

 SHOP SIZE- 15 SQM/161 SQF



# COFFEE BAR



Within the dynamic airport **food court**, the retail unit stands out with a contemporary and highly **recognizable image**, built around a compact counter enriched by refined material details. The front, defined by an **elegant dark marble** effect with light veining, interacts with **light wood slatted surfaces**, creating a visual balance between **solidity and warmth**. The project clearly expresses the typical chromatic codes of **contemporary coffee shops**, reinterpreted through a carefully balanced mix of natural materials and more distinctive accents. The warm tones of the wood, used in the counter cladding, immediately evoke a sense of familiarity and authenticity, recalling the **artisanal tradition** associated with the world of coffee.





















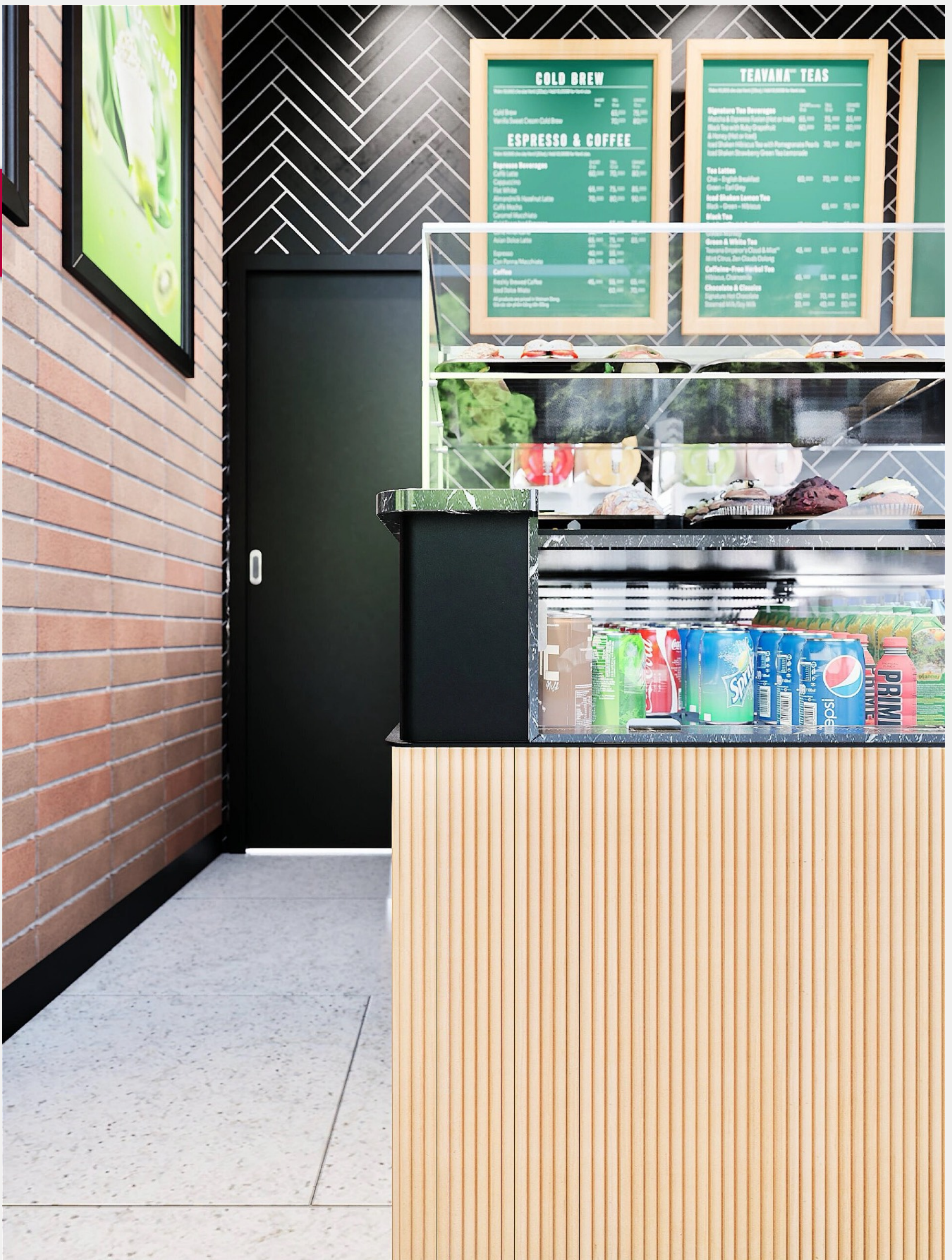



## VIRTUAL TOUR

Discover our virtual environments: **explore in 3D the spaces designed for you**, experience immersive engagement, and make confident decisions. **Find the right inspiration** to create a tailor-made, innovative, and unique venue.



Virtual Tour



## MOODBOARD

**Black marble with white veining dominates the work surfaces, conveying an industrial elegance. The black porcelain stoneware wall cladding in a herringbone pattern creates depth and movement, while the exposed brick on the side wall introduces a raw and authentic touch. The light wood front panels of the counter (ash or bleached oak) balance the harshness of the dark palette with warmth and naturalness.**

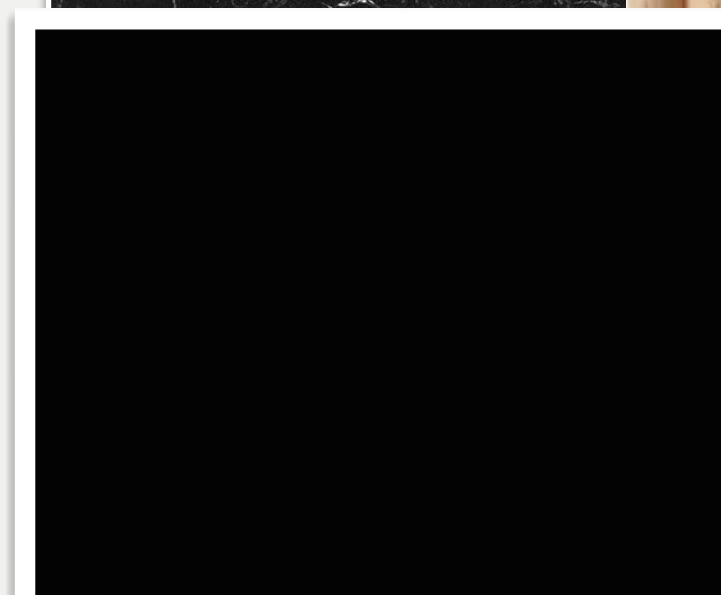

**RAL 9005**





## FLOOR PLAN

The “Coffee To Go” layout is designed to ensure efficiency throughout different times of the day, optimizing workflow and operations. The arrangement highlights the core business of the space: the coffee machine, positioned frontally, becomes the focal point and showcases the barista’s gestures, enhancing the experience and reinforcing the perception of quality. and the use of marble with visible chips, a material that helps evoke retro atmospheres with a touch of sophistication.

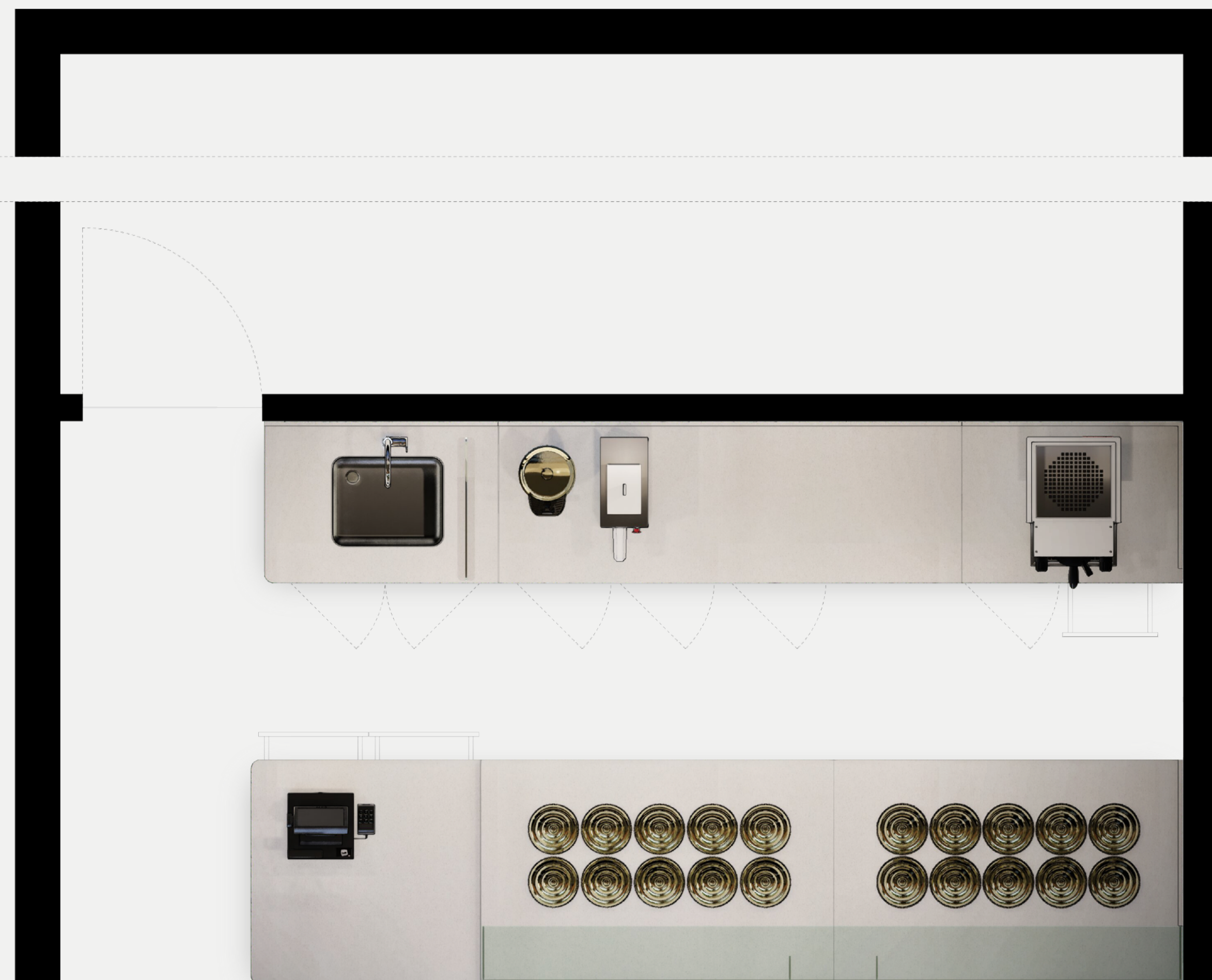



## LAY-OUT

In just 15sqm/160 sqf, this Caffetteria “To Go” format transforms a compact space into an efficient and high-performing system, designed for fast, high-quality service. The linear counter concentrates all essential functions, while the front-facing coffee machine becomes both the visual and operational focal point. The back-of-house areas, though minimal, are well organized to ensure smooth, interference-free movements, optimizing workflow and enhancing service speed.

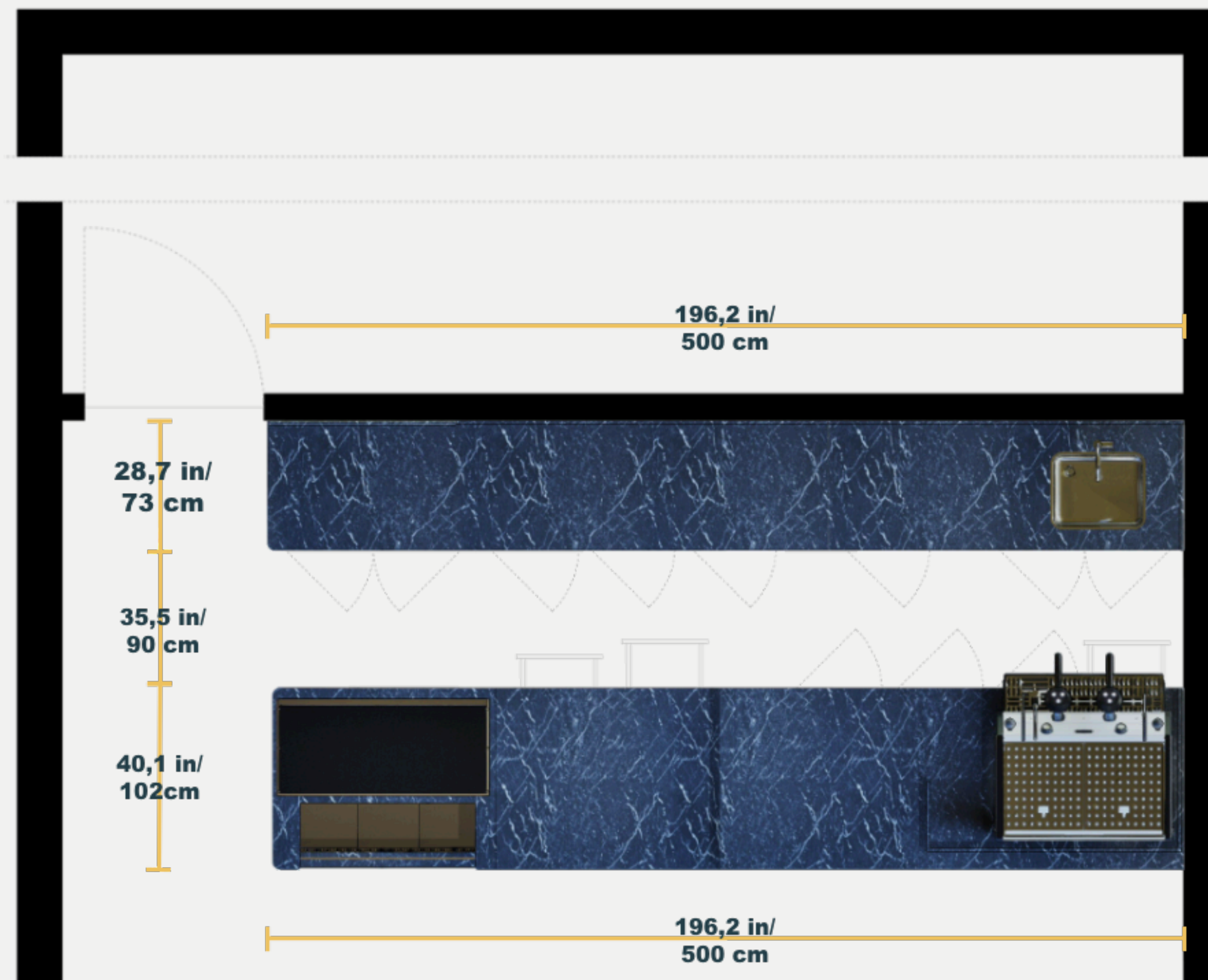

## FURNITURE LIST



### Furniture list - front counters:

- 1-Checkout counter
- 2-Pozzetti Counter 10 flavors
- 3-Pozzetti Counter 10 flavors

### Furniture list - back counters:

- 4-Back counter sink
- 5-Back counter Three doors refrigerated
- 6-Back counter Coffee machine

## 1 - REFRIGERATED GRAB & GO DISPLAY CASE



- Stainless steel frame
- Front Glass
- Front panels made galvanized steel
- Plinth coated made galvanized steel
- Compressor unit

**Grab & Go Display case integrated into the furniture, entirely made of stainless steel.**

Ensuring maximum product visibility at all times. Designed with a strong focus on ergonomics, it offers customers an optimal view of the drinks.

It features a **professional control system** for precise temperature management and **integrated refrigeration units**. The **Silestone® Cosentino** surface guarantees durability and easy cleaning, while the front panels in **painted galvanized steel** with high-resistance finishes complete the structure, combining robustness with essential aesthetics.

Checkout counter top in Silestone®

Dim: **W**x**L**x**H**

inch: **40,1** x **49,2** x **33,8**

cm: **102** x **125** x **86**

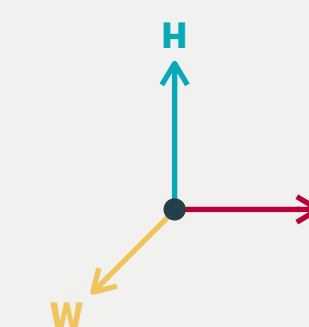

## 2 - CHECKOUT COUNTER



- Stainless steel frame
- 2 Stainless steel drawer
- 1 Stainless steel shelves
- Front panels made galvanized steel
- Plinth coated made galvanized steel

The checkout counter, with a **fully stainless steel frame**, is designed to ensure efficiency and organization in any operational setting. Equipped with **large stainless steel drawers and shelf**, it offers a durable, hygienic, and functional solution for space management. The Silestone® Cosentino surface guarantees long-lasting performance and easy cleaning, while the **front panels**, made of Silestone with **high-resistance finishes**, complete the structure by combining strength with essential aesthetics.

Pozzetti counter top in Silestone®

Dim: **W**x**L**x**H**

inch: **40,1** x **49,6** x **37**

cm: **102** x **126** x **94**

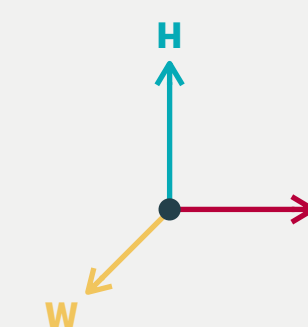

 **3 - FRONT COUNTER 2 DOORS REFRIGERATED**



- Stainless steel frame
- 2 Doors refrigerated cabinet
- Front panels made galvanized steel
- Plinth coated made galvanized steel

The refrigerated cell, with a fully stainless steel structure, is designed to ensure maximum hygiene, durability, and reliability. Equipped with an **on-board refrigeration unit**, it provides precise temperature control in all operating conditions. The **Silestone® Cosentino** surface completes the system, offering high durability and easy cleaning.

Pozzetti counter top in Silestone®

Dim: **W**x**L**x**H**  
inch: **40,1** x **63,7** x **37**  
cm: **102** x **162** x **94**

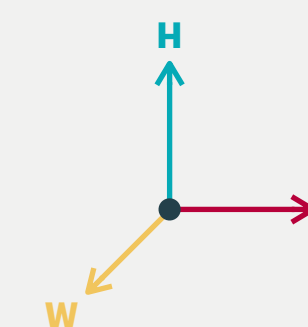

## 4 - FRONT COUNTER COFFEE MACHINE



- Stainless steel frame
- 1 Stainless steel Cabinet doors
- 2 Stainless steel shelves
- Front panels made galvanized steel
- Plinth coated made galvanized steel

The coffee machine back counter, made entirely of stainless steel with a stainless steel door, is designed to ensure durability, hygiene, and everyday practicality. Equipped with **two hoppers for coffee preparation**, it offers an efficient and functional solution for industry professionals. The **Silestone<sup>®</sup> Cosentino** surfaces ensure long-lasting performance, easy cleaning, and a refined look—ideal even for areas visible to customers.

Pozzetti counter top in Silestone<sup>®</sup>

Dim: **W**x**L**x**H**

inch: **40,1** x **39,3** x **37**

cm: **102** x **100** x **94**

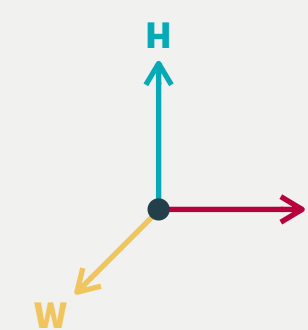



## 5 - BACK COUNTER

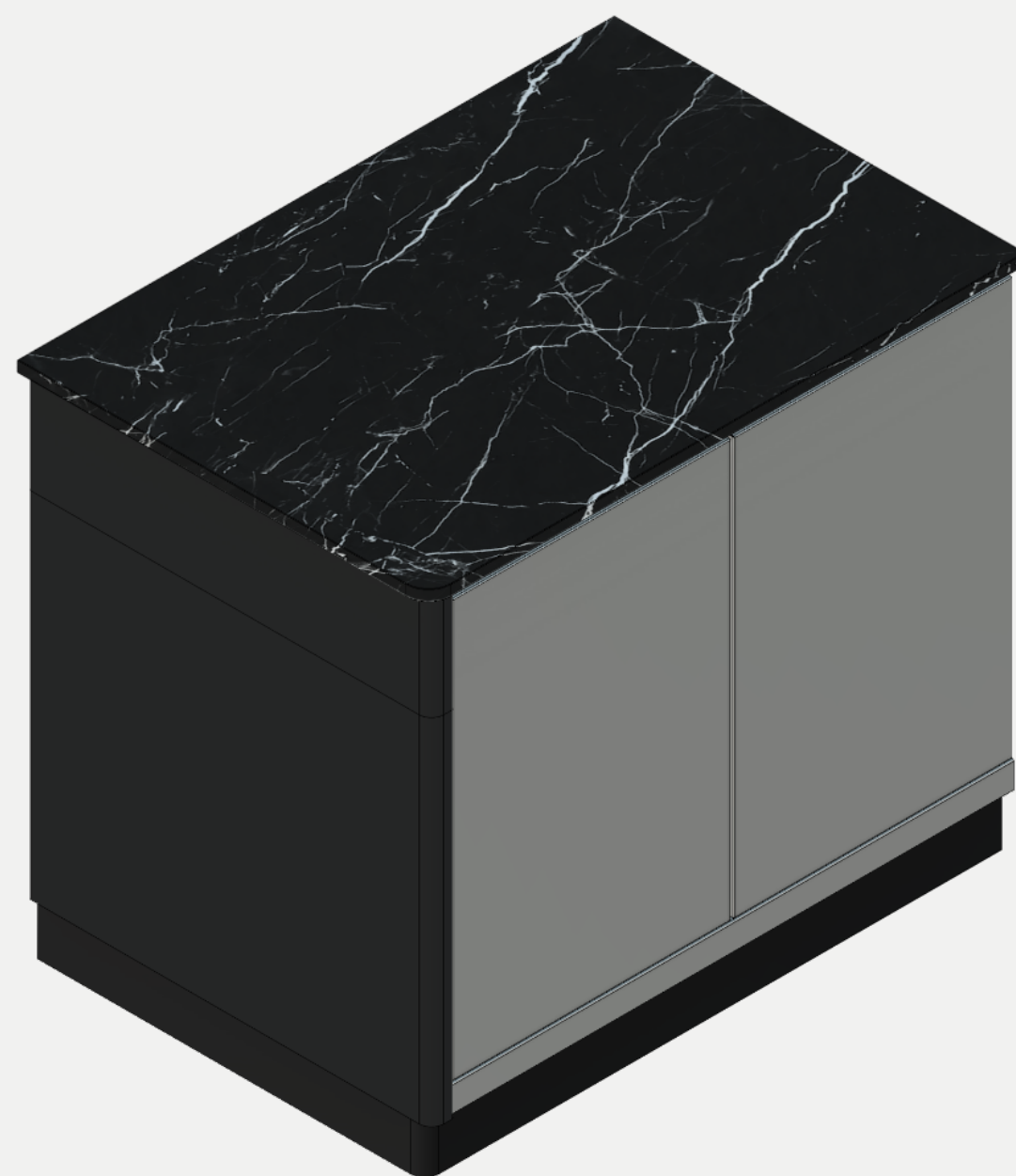

- Stainless steel frame
- 2 Stainless steel Cabinet doors
- Front panels made galvanized steel
- Plinth coated made galvanized steel

The checkout counter, with a **fully stainless steel frame**, is designed to ensure efficiency and organization in any operational setting. Equipped with **large stainless steel shelf**, it offers a durable, hygienic, and functional solution for space management. The Silestone® Cosentino surface guarantees long-lasting performance and easy cleaning.

Pozzetti counter top in Silestone®

Dim: **W**x**L**x**H**

inch: **28,7** x **41,7** x **37**

cm: **73** x **106** x **94**

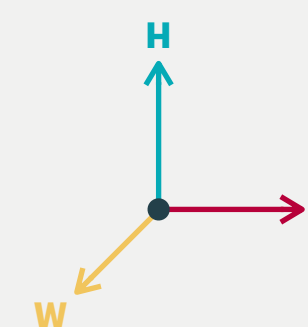

 **6 - BACK COUNTER 3 DOORS REFRIGERATED**



- Stainless steel frame
- 3 Doors refrigerated cabinet
- compressor unit
- Plinth coated made galvanized steel

The refrigerated cell, with a fully stainless steel structure, is designed to ensure maximum hygiene, durability, and reliability. Equipped with an **on-board refrigeration unit**, it provides precise temperature control in all operating conditions. The **Silestone® Cosentino** surface completes the system, offering high durability and easy cleaning.

Pozzetti counter top in Silestone®

Dim: **W**x**L**x**H**

inch: **28,7** x **82,7** x **37**

cm: **73** x **210** x **94**

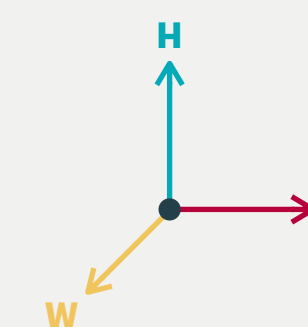



## 7 - BACK COUNTER WASHER CABINET+ NEUTRAL CABINET



- Stainless steel frame
- 1 Stainless steel Cabinet doors
- 1 stainless steel washer cabinet
- Plinth coated made galvanized steel

The checkout counter, with a **fully stainless steel frame**, is designed to ensure efficiency and organization in any operational setting. Equipped with **large stainless steel shelf**, it offers a durable, hygienic, and functional solution for space management. The Silestone® Cosentino surface guarantees long-lasting performance and easy cleaning.

Pozzetti counter top in Silestone®

Dim: **W**x**L**x**H**

inch: **28,7** x **39,3** x **37**

cm: **73** x **100** x **94**

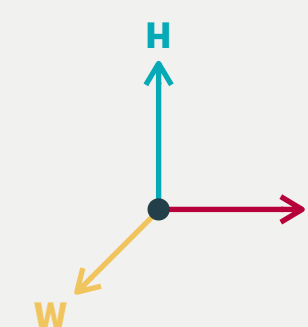



## 8 - BACK COUNTER SINK



- Stainless steel frame
- 2 Stainless steel Cabinet doors
- Stainless steel sink and tap
- Plinth coated made galvanized steel

The professional **sink unit**, with a **fully stainless steel frame and doors**, is designed to ensure durability and functionality in demanding work environments. Equipped with a **large sink** and **professional faucet**, it combines practicality and ease of use while remaining **elegant and visually appealing to the public**. The Silestone® Cosentino surface guarantees durability and easy cleaning

Pozzetti counter top in Silestone®

Dim: **W**x**L**x**H**

inch: **28,7** x **39,3** x **37**

cm: **73** x **100** x **94**

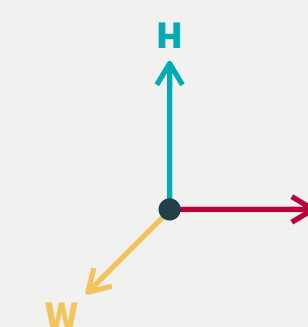



## SPLASH GUARD

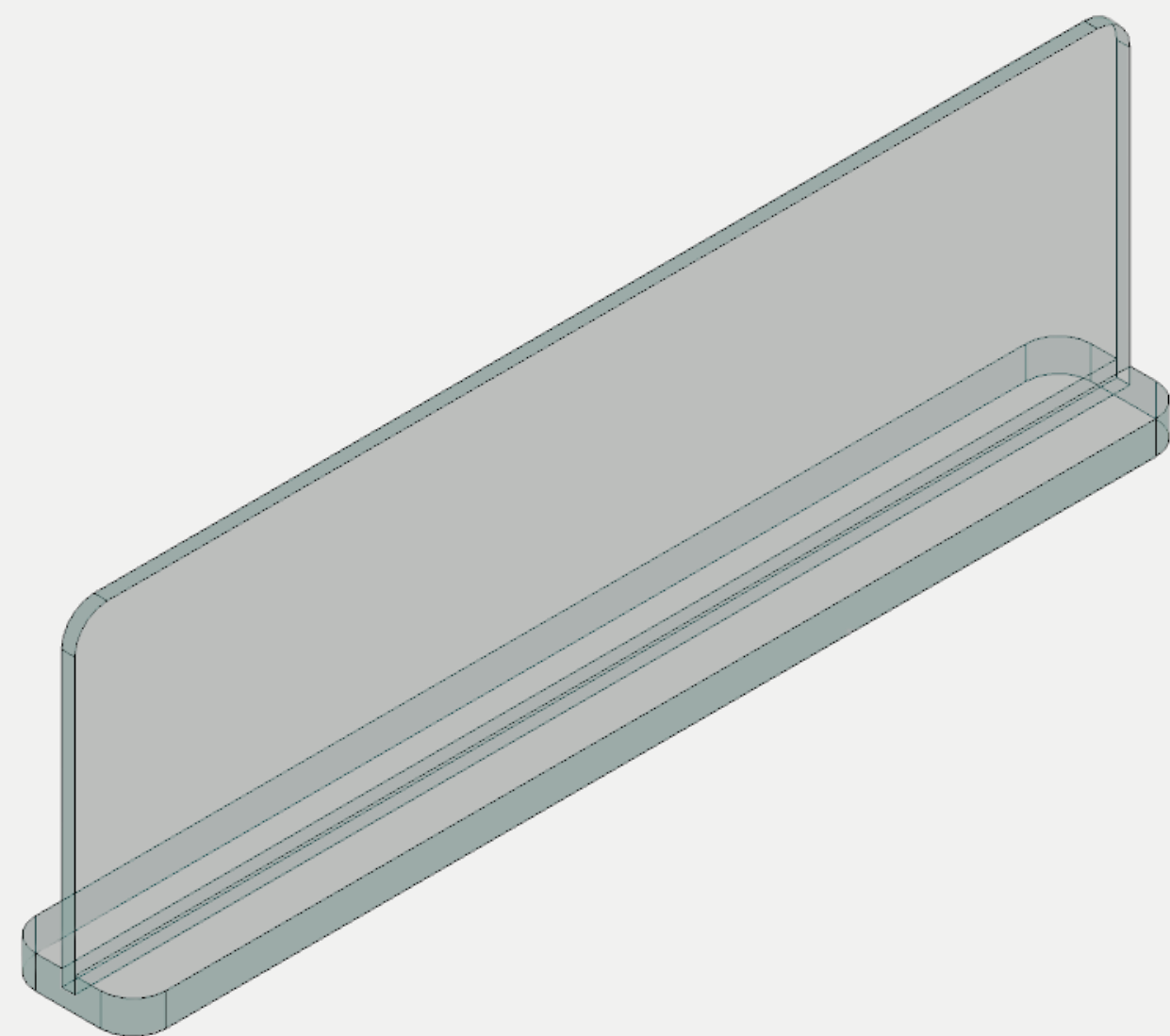

-N2 Splash Guard

### Transparent polycarbonate splash guard

Provides safe protection while keeping the work area clean, without compromising the aesthetic of the space thanks to its transparency and discreet design.

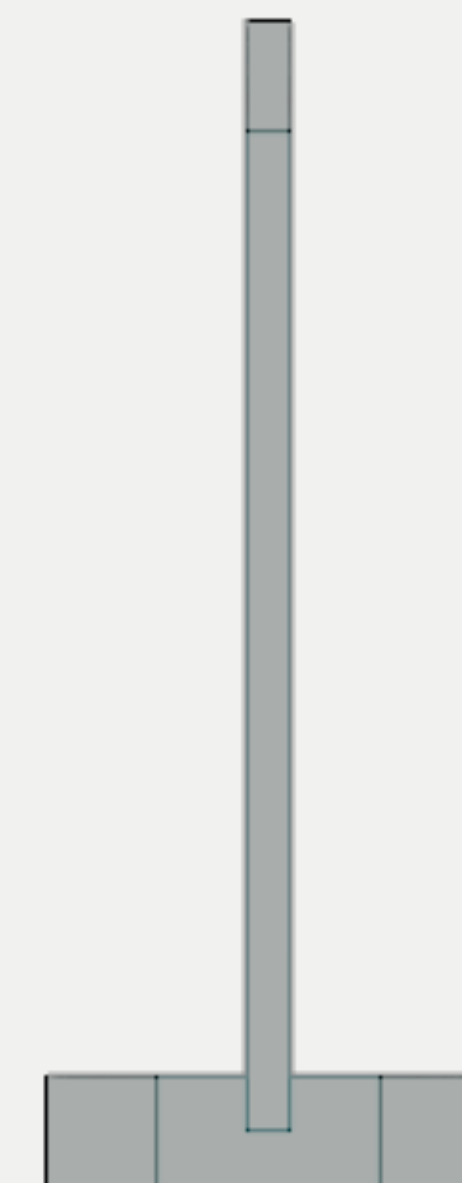

Polycarbonate

Dim: **W**x**L**x**H**

inch: **27,5** x **4,7** x **8,7**

cm: **70** x **12** x **22**

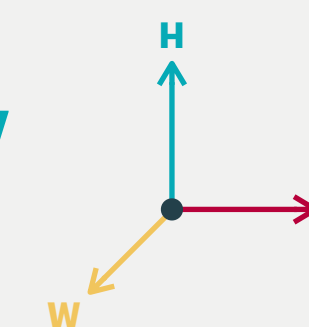



## I RIVESTIMENTI: I PIANI

# silestone®

By COSENTINO®

A leading brand for over 30 years that inspires designs for kitchens, bathrooms and commerciale surfaces.

**25 Years warranty**  
Hybrid mineral surfaces to create innovative spaces that endure over the time.

### Advantages and properties



**Elevata resistenza ai graffi**  
l'uso e l'usura quotidiana non graffiano Silestone.

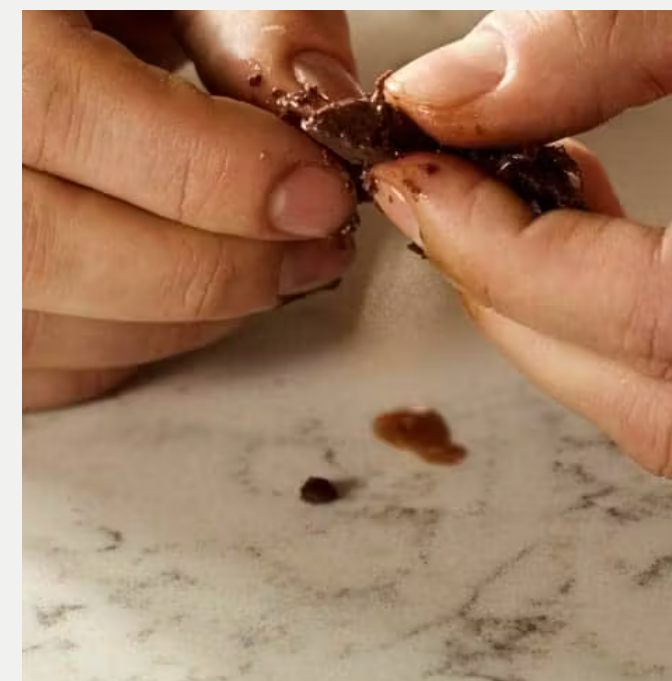

**Elevata resistenza alle macchie**  
La bassa porosità li rende altamente resistenti alle macchie.



**Alta resistenza agli urti**  
Altamente resistente agli impatti quotidiani.

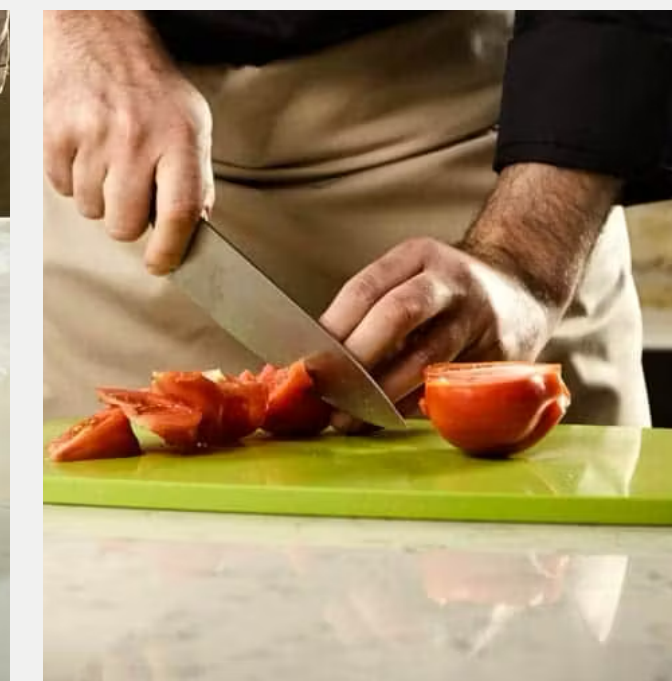

**Elevata resistenza agli acidi**  
La bassa porosità gli impedisce di essere danneggiato da macchie aggressive.

### Finish



**Polished**  
More vibrant and intense colors and reflections

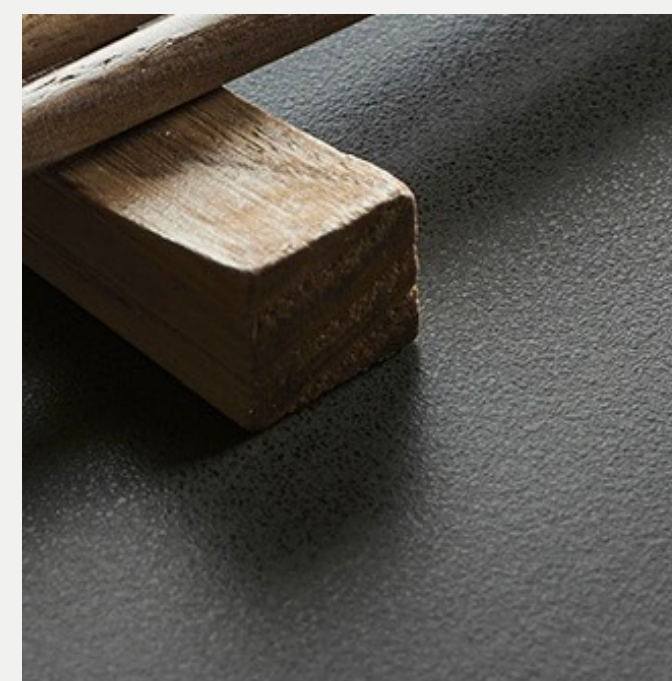

**Suede**  
Soft and pleasant feel with full color consistency

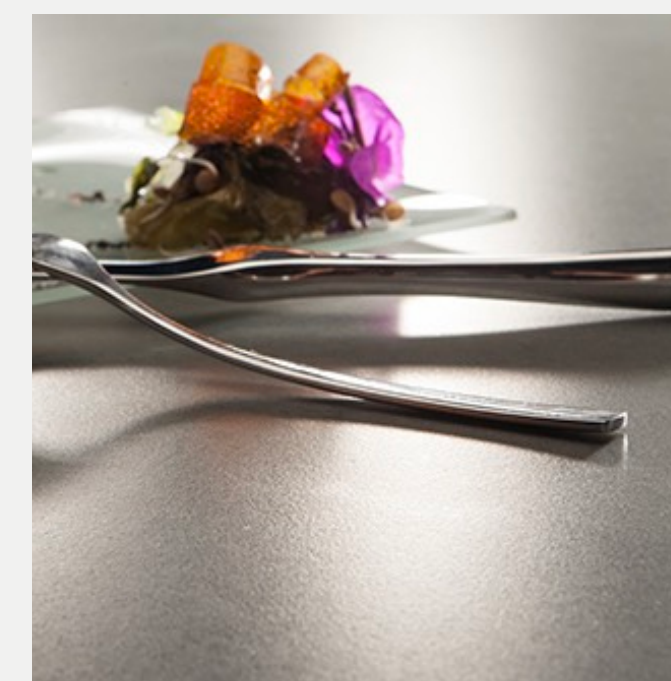

**Mate**  
Solid and satin color

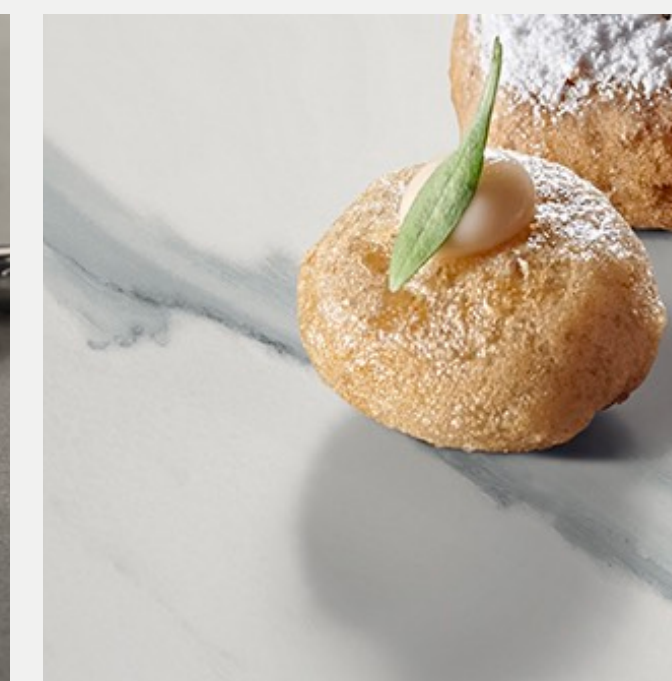

**Velvet**

## Maintenance



Click the colors to see them in use

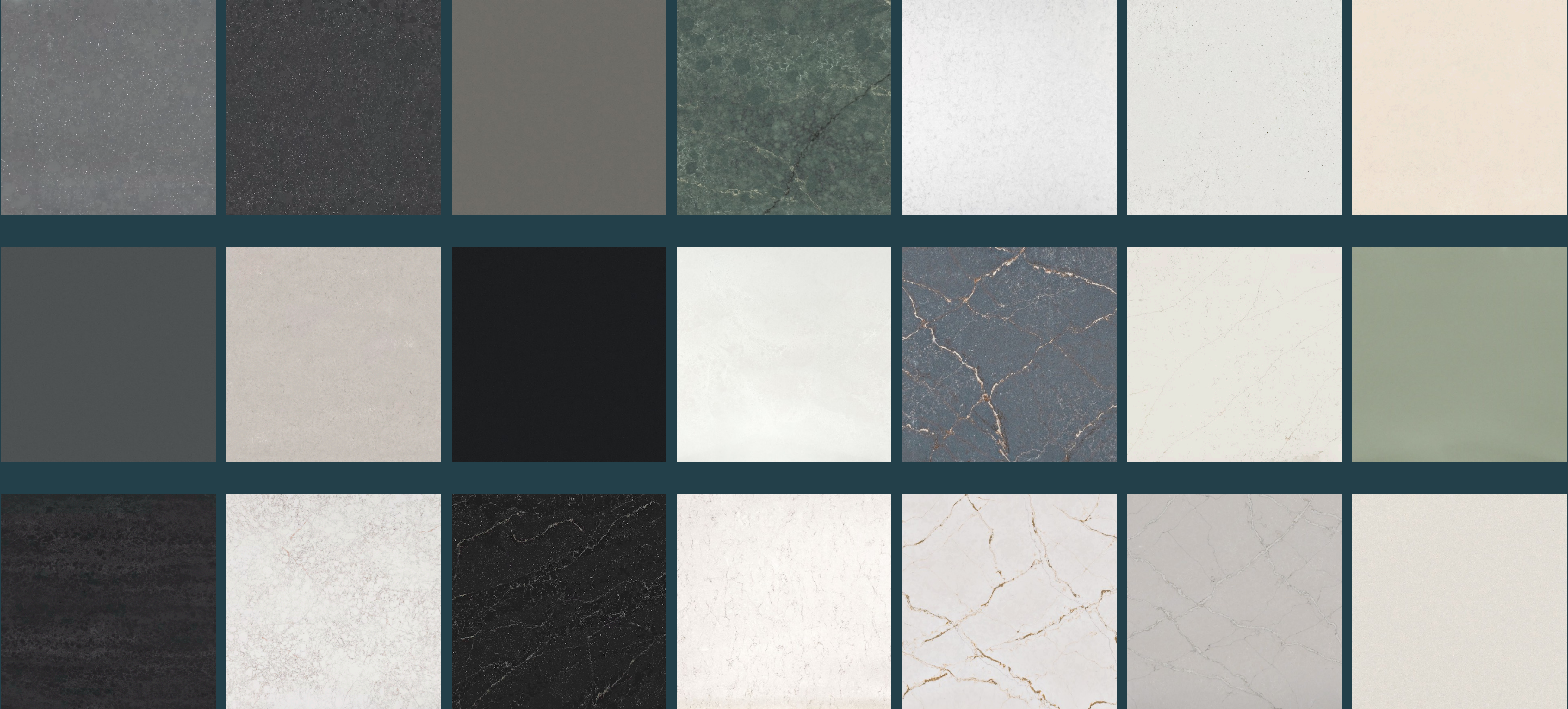

 **COLORS WITHOUT LIMITS**



[RAL Chart](#)

**PANTONE®**

[Pantone Chart](#)

**kerakoll**

[Kerakoll Chart](#)

With TekneItalia, you're never confined to a preset color palette. **We offer access to thousands of colors** through internationally recognized systems like **RAL** and **PANTONE\***, ensuring your customization is truly **limitless**. Whatever shade you envision, we can bring it to life—without compromises and without boundaries.

 **COLORS WITHOUT LIMITS**

# 3M

# DI-NOC™

**3M™ DI-NOC™ Architectural** E-Series PO Polyolefin Film are film surface finishes that give you a range of choices as you pursue your sustainability goals. These films are made with approximately 99.5% non-PVC (non-vinyl) materials, and do not contain more than 0.5% of a polyvinyl chloride-based component. **These finishes are available in various patterns and textures – wood, plaster, concrete and more, and are a great way to upgrade your interior look without all the disruption.** 3M™ Comply™ Adhesive technology virtually eliminates air bubbles, simplifying and speeding up the application process.



**Catalogue 3M Di - NOC**



## TOTAL CUSTOMIZATION

With TekneItalia, every piece of furniture becomes a **unique expression of your brand**. **Integrated “under-surface” digital graphics, stencil techniques, and glossy or matte finishes are just some of the available options.** Thousands of combinations of materials, colors, and details allow you to create truly tailor-made solutions, with no limits to customization.





## PROMINENT DETAILS

**Laser-engraved details add depth and personality to the furniture**, with the option to be painted or finished with an elegant 24-carat gold plating. **Custom-made**, these exclusive elements transform any space, making your venue unique and **instantly recognizable**.



THIS IS A **TEKNEITALIA**® PROJECT

**Tekneitalia** is a company founded **over 15 years ago** with the clear and ambitious goal of revolutionizing the way business is done in the HO.RE.CA. sector. Through **carts and mobile devices with iconic and highly recognizable design**, we have made **beauty a tool for work**. From day one, our mission has been to offer clients **not only functional tools but true extensions of their identity**: objects capable of expressing **values, emotions**, and visions through a refined and **timeless aesthetic**.

**TEKNEITALIA**®  
Brows our website



**TEKNEITALIA**®



**YOUR PROJECT, GUIDED BY EXPERT**

A dedicated team of **architects and graphic designers** will support you at every stage of development, working closely with you to create the best version of your project. Thanks to 3D modeling in a virtual environment, you'll be able to explore every detail of your venue before implementation, choosing each element with precision and ensuring a flawless result.

Contact us and **share your needs** to discover how we can **turn your project into reality**. Receive detailed information and a personalized quote, with **no obligation**.

**[INFO@TEKNEITALIA.COM](mailto:INFO@TEKNEITALIA.COM)**

**MOBILE OFFICE: +39 328 221 34 74**

**MOBILE SALES EXPORT: + 39 366 421 23 63**

**TEKNEITALIA USA: +1 212 810 6725**