

 SHOP SIZE- 40 SQM/430 SQF

PASTRY SHOP





Project for a pastry shop located in the city center, conceived as a dynamic and welcoming space. **Articulated aesthetic** elements and **decorative details inspired by cake doilies** and the world of pastry-making, reinterpreted in a contemporary way as light textures and graphic patterns.

The graphic motif rises from a two-dimensional surface and takes shape as the **coffee counter upstand**, enriched with bronze-colored inlays that enhance its materiality and visual presence. Beyond defining the project's identity, this element conceals the **coffee preparation area** and integrates seamlessly with the counter, combining **function** and **formal continuity**.

































VIRTUAL TOUR

Discover our virtual environments: **explore in 3D the spaces designed for you**, experience immersive engagement, and make confident decisions. **Find the right inspiration** to create a tailor-made, innovative, and unique venue.



Virtual Tour



MOODBOARD

A design approach focused on **integrating the counter within a broader and cohesive interior system**, where each element contributes to building a **unified** and **recognizable** identity. The counter, finished in **metallic pink**, becomes the focal point of the space and reinterprets the traditional **cake doily pattern**—an iconic element of pastry-making—transforming it into a **contemporary graphic feature**.

Behind it, a geometric backdrop of interwoven arches and circles creates a decorative pattern in shades of **gold, blue, rose** and **bronze**, adding depth and visual rhythm. The same double-arch motif is echoed in the glazing of the laboratory, which is directly visible from the display area, reinforcing formal continuity and strengthening the dialogue between production and retail.





FLOOR PLAN

Conceived for the **high-traffic** conditions typical of a city-center pastry shop, the system ensures **speed of service, clear circulation flows**, and immediate access to products, supporting a dynamic and efficient experience consistent with the **grab-and-go concept**.

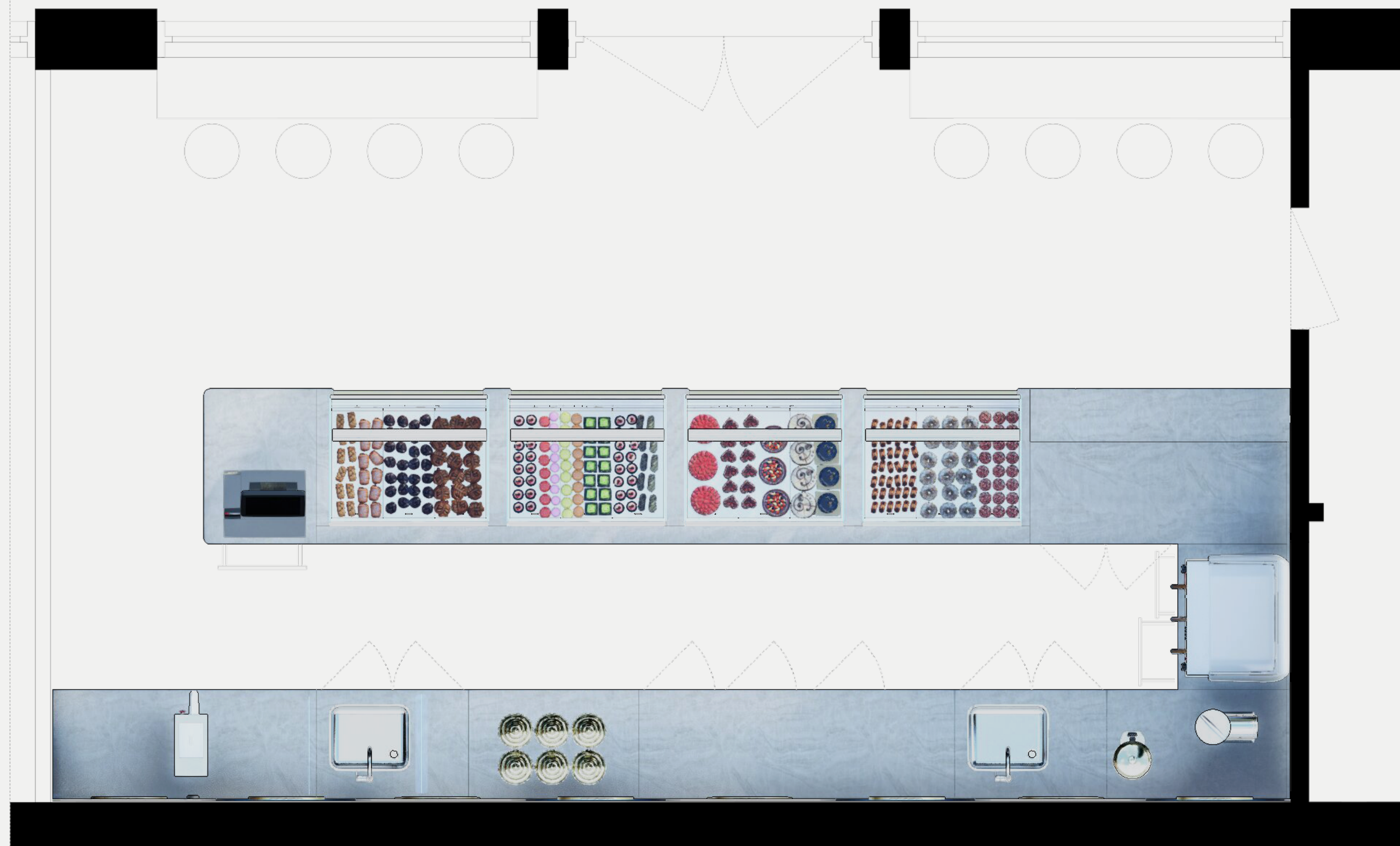



LAY-OUT

The layout in **430 sqf** is designed to seamlessly **integrate** the **pastry area** with the **coffee preparation zone**, creating a continuous and functional space that encourages interaction between display, service, and production. The arrangement of elements optimizes operational paths and **minimizes interference** between staff and customers.

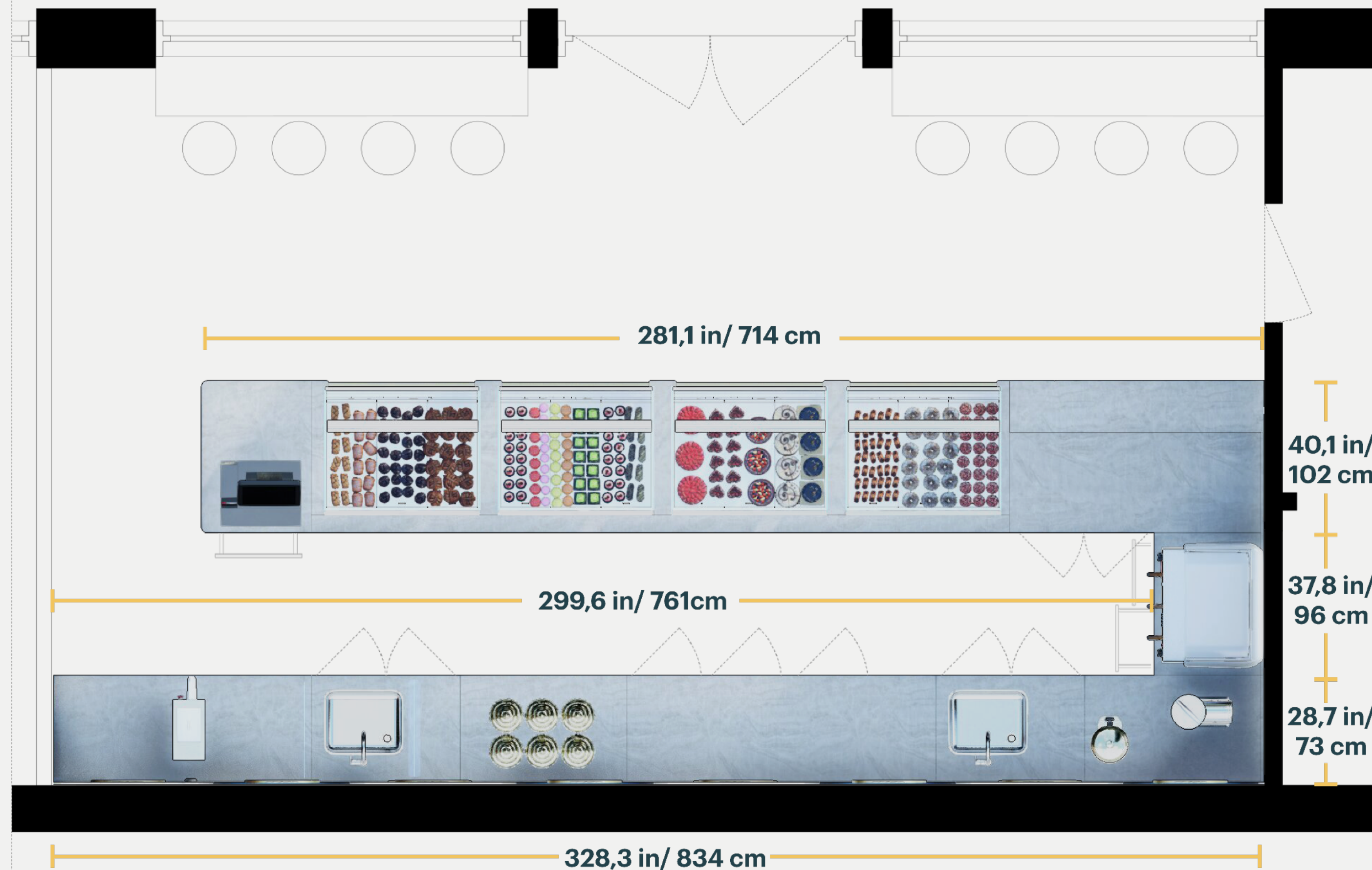

FURNITURE LIST

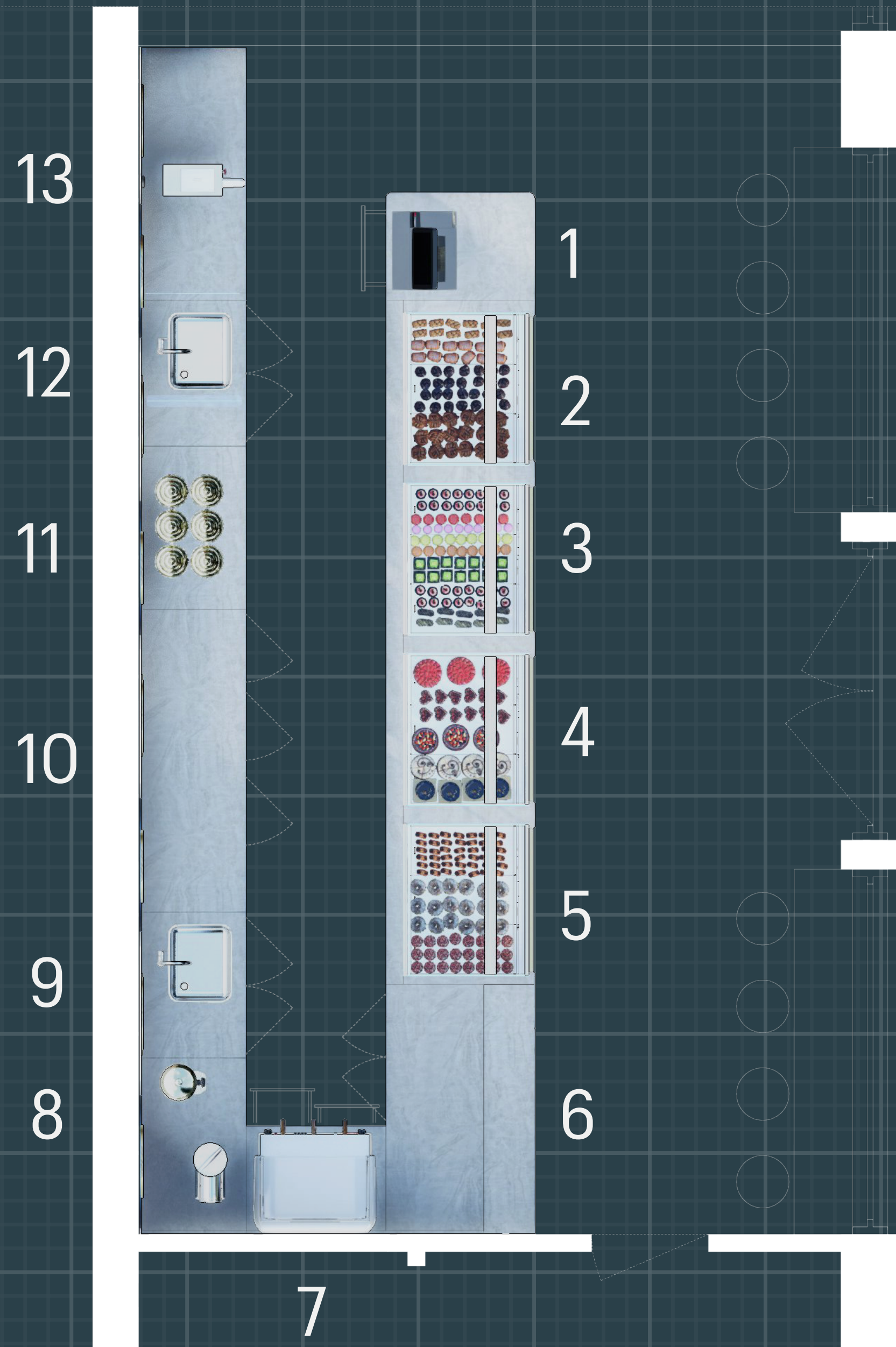

Furniture list - front counters:

- 1-Checkout counter
- 2-Refrigerated Pastry Display case
- 3-Refrigerated Pastry Display case
- 4-Refrigerated Pastry Display case
- 5-Refrigerated Pastry Display case
- 6-Coffee counter with two doors refrigerated

Furniture list - back counters:

- 7-Back Coffee counter Coffee machine
- 8-Neutral Back counter
- 9-Back counter sink
- 10-Back counter Three doors refrigerated
- 11-Back Pozzetti Counter 6 flavors
- 12-Back counter sink
- 13-Neutral Back counter

1 - CHECKOUT COUNTER

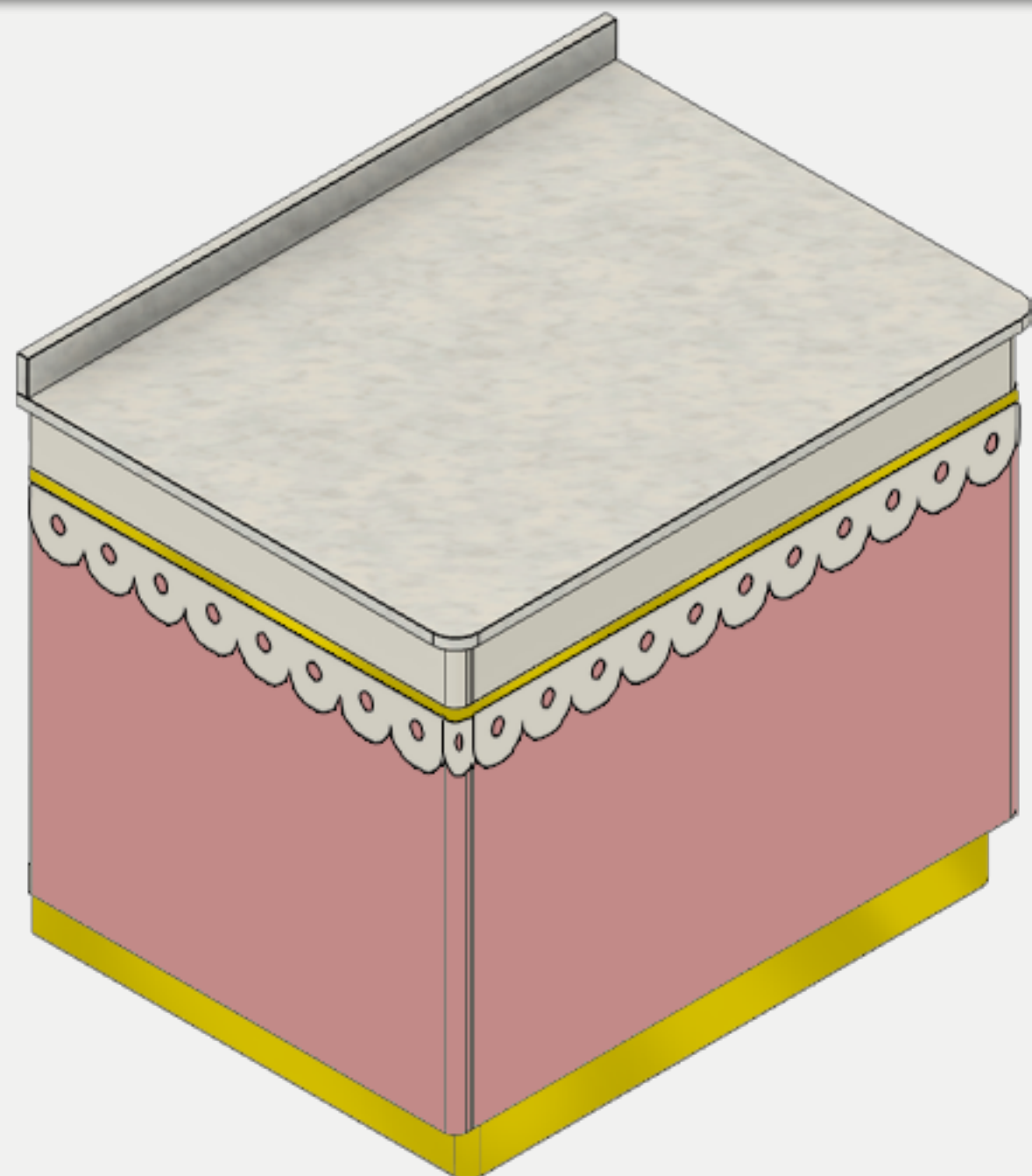

- Stainless steel frame
- 1 Stainless steel drawer
- 1 Stainless steel shelves
- Front panels made galvanized steel
- Plinth coated made galvanized steel

The checkout counter, with a **fully stainless steel frame**, is designed to ensure efficiency and organization in any operational setting. Equipped with **large stainless steel drawers and shelf**, it offers a durable, hygienic, and functional solution for space management. The Silestone® Cosentino surface guarantees long-lasting performance and easy cleaning, while the **front panels**, made of powder-coated galvanized steel with **high-resistance finishes**, complete the structure by combining strength with essential aesthetics.

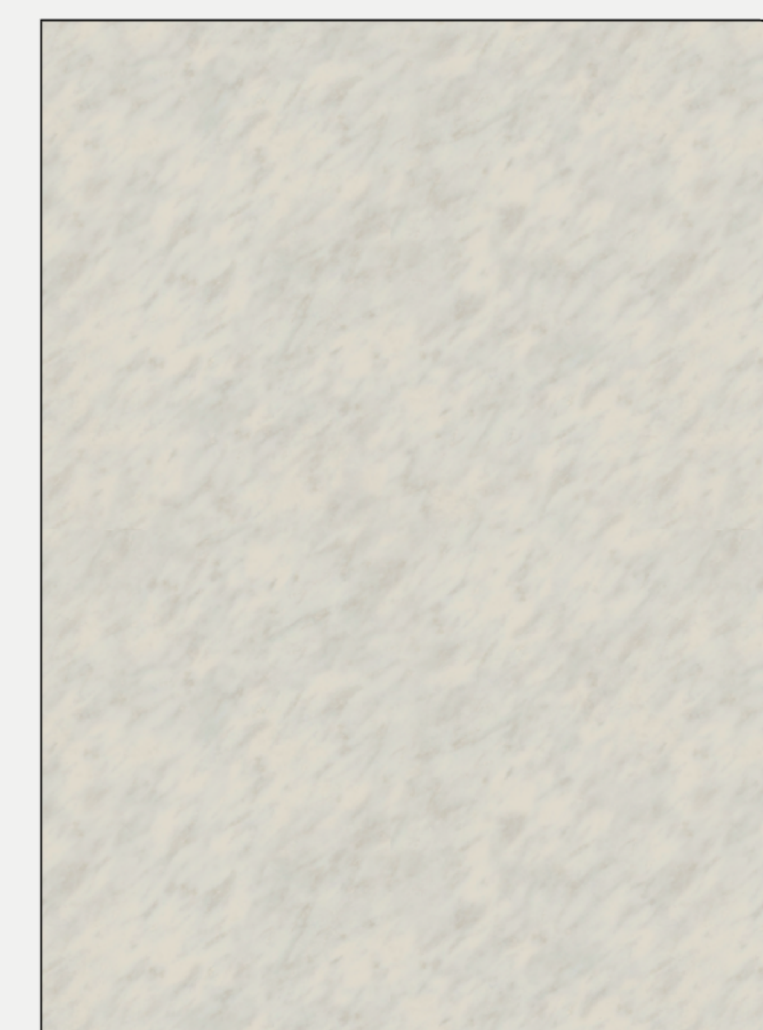

Checkout counter top in Silestone®

Dim: **W**x**L**x**H**
inch: **40,1** x **29,1** x **33,8**
cm: **102** x **74** x **86**

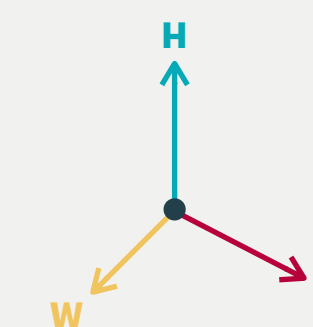

 2/3/4/5 - REFRIGERATED PASTRY DISPLAY CASE

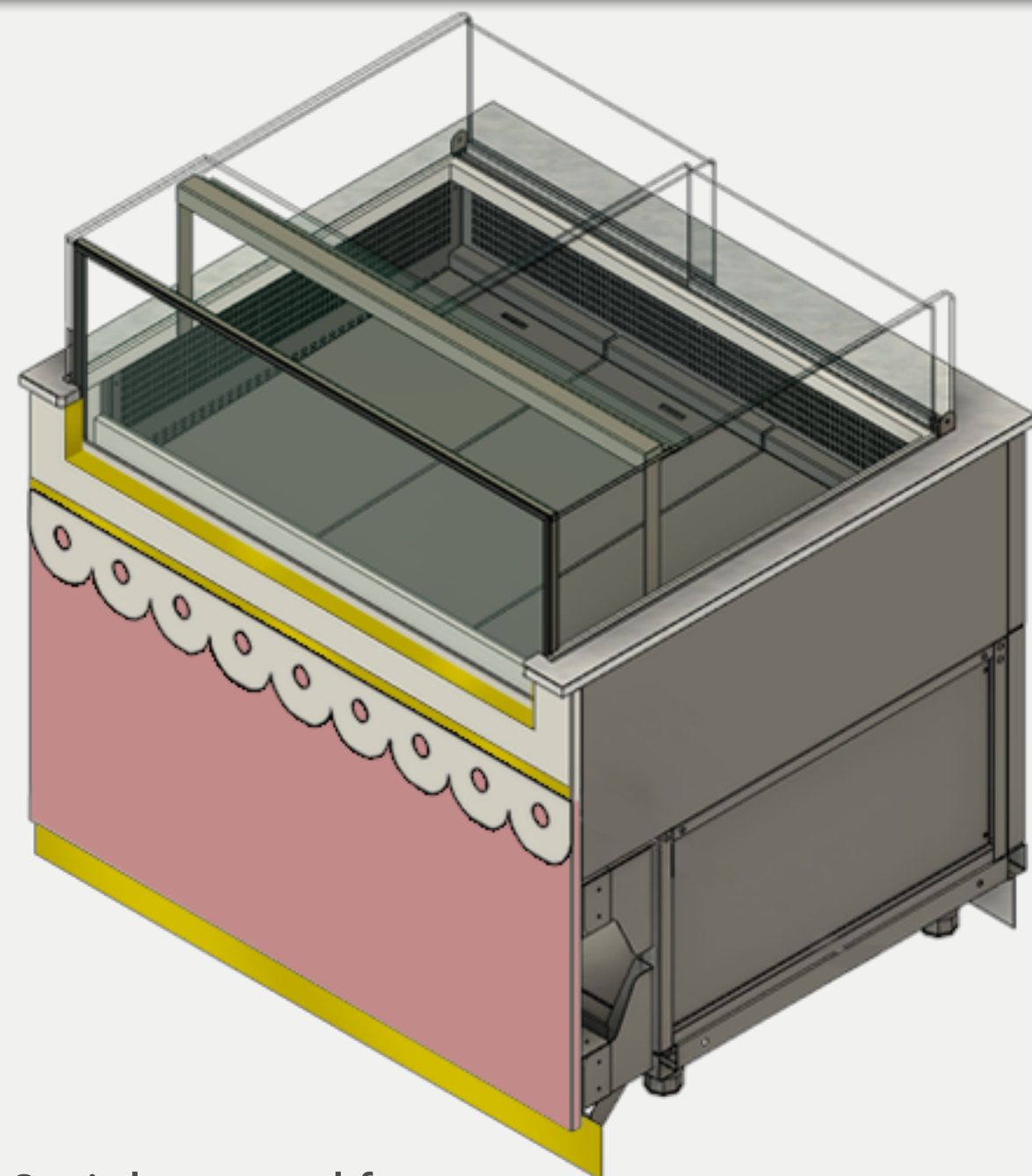

- Stainless steel frame
- 1 Stainless steel drawer
- heated double front glass
- Front panels made galvanized steel
- Plinth coated made galvanized steel
- compressor unit

Pastry display case integrated into the furniture, entirely made of stainless steel.

The heated double-glass front prevents fogging, ensuring maximum product visibility at all times. Designed with a strong focus on ergonomics, it offers customers an optimal view of the gelato while providing the operator with practicality and comfort in daily use.

It features a **professional control system** for precise temperature management and **integrated refrigeration units**. The **Silestone® Cosentino** surface guarantees durability and easy cleaning, while the front panels in **painted galvanized steel** with high-resistance finishes complete the structure, combining robustness with essential aesthetics.

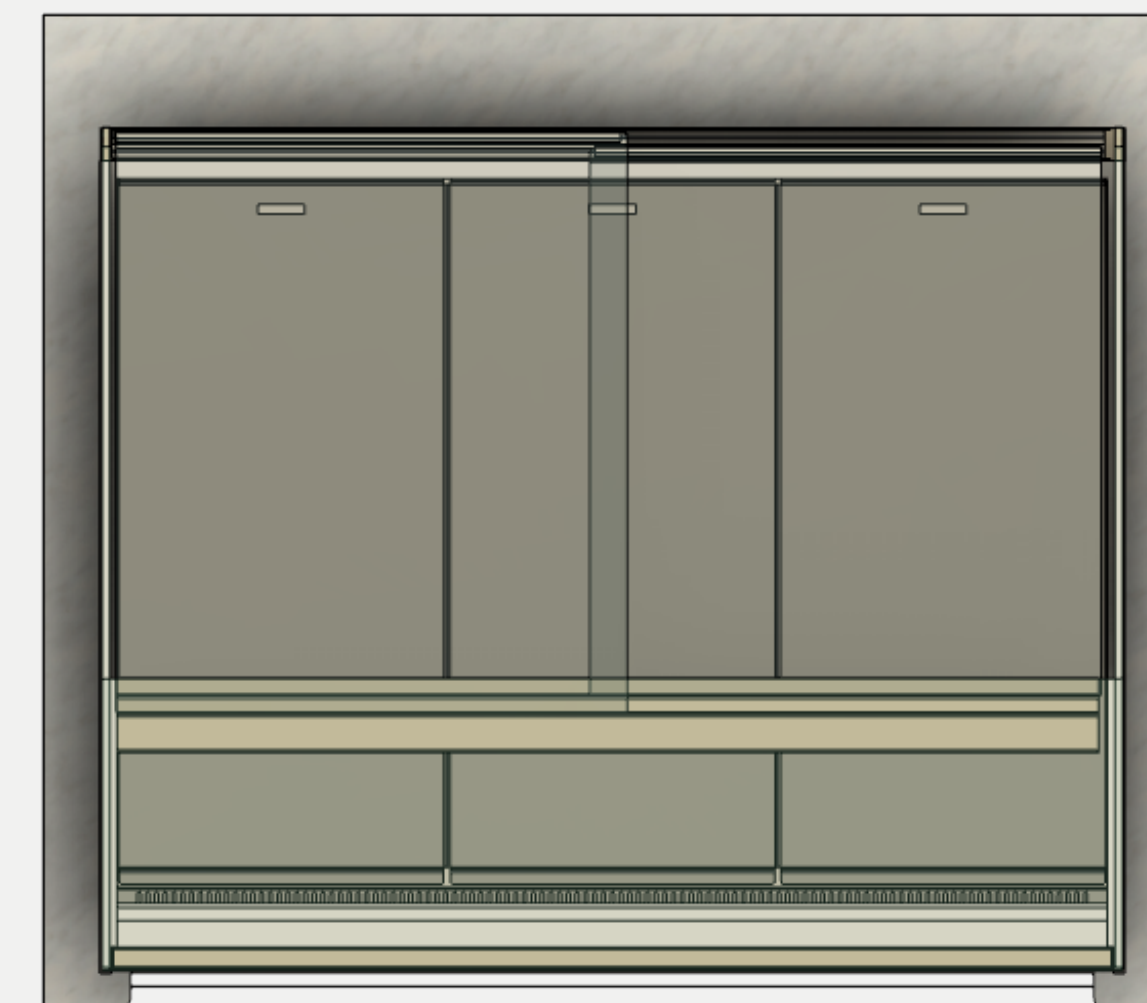

Pozzetti counter top in Silestone®

Dim: **W**x**L**x**H**
inch: **40,1** x **47,2** x **37**
cm: **102** x **120** x **94**

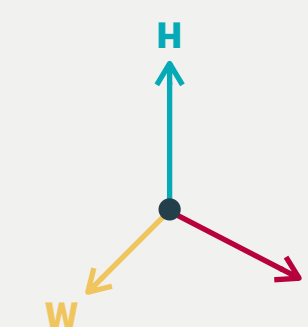



6 - COFFEE COUNTER

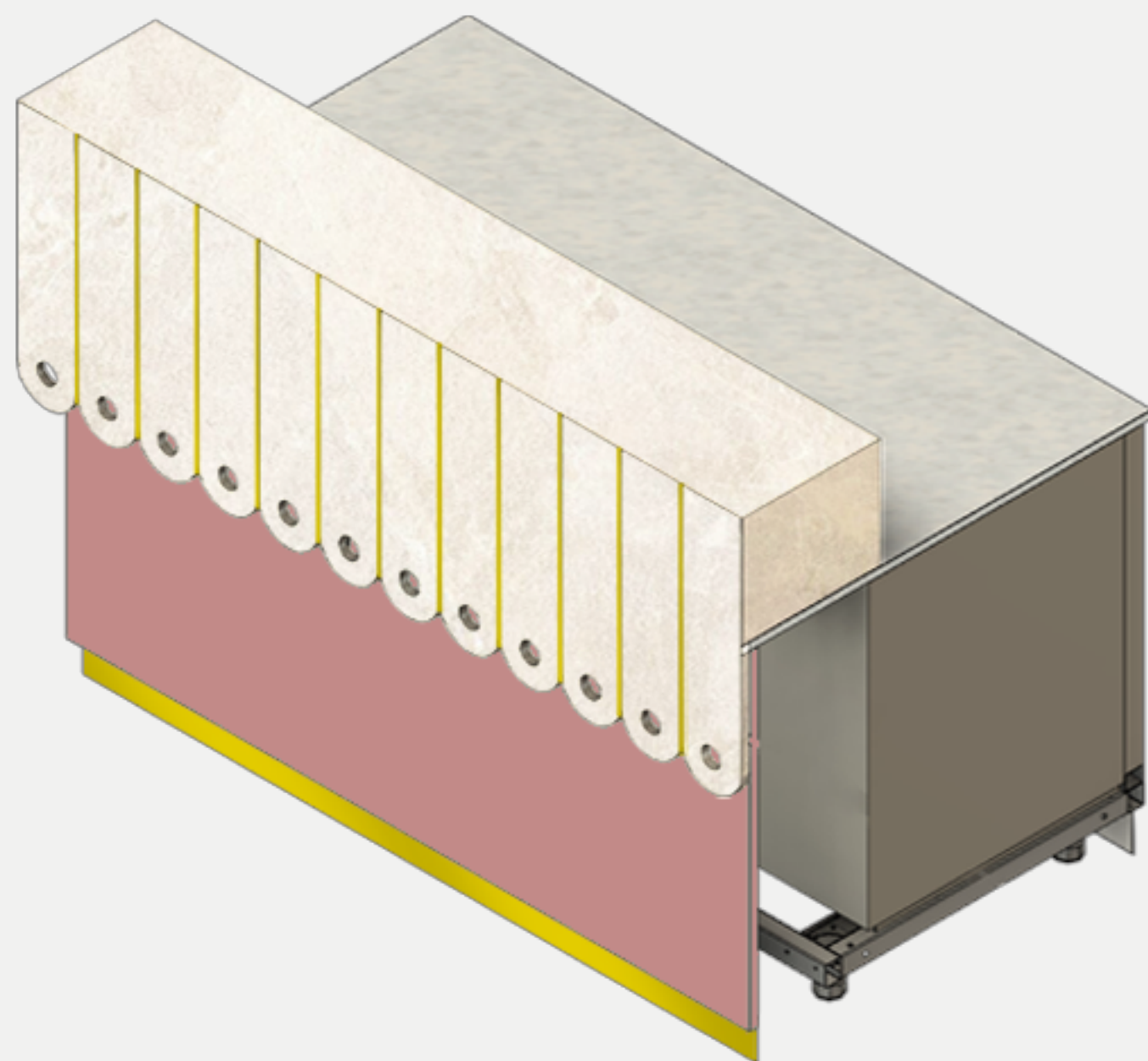

- Stainless steel frame
- 1 Stainless steel drawer
- 2 Stainless steel shelves
- Front panels made galvanized steel
- Plinth coated made galvanized steel
- double refrigerated compartment

Coffee counter with a **fully stainless-steel frame**, designed to ensure strength, hygiene, and professional performance. The structure integrates a **double refrigerated compartment**, ideal for storing and preparing milk dedicated to **latte art**, optimizing workflow during service.

The unit is completed by an elegant custom-made **Silestone® by Cosentino** upstand, seamlessly integrated with the worktop to ensure durability, resistance, and ease of cleaning. Front panels in **painted galvanized steel**, finished with high-resistance coatings, define the counter's aesthetic while completing the structure, combining robustness with a clean, essential design.

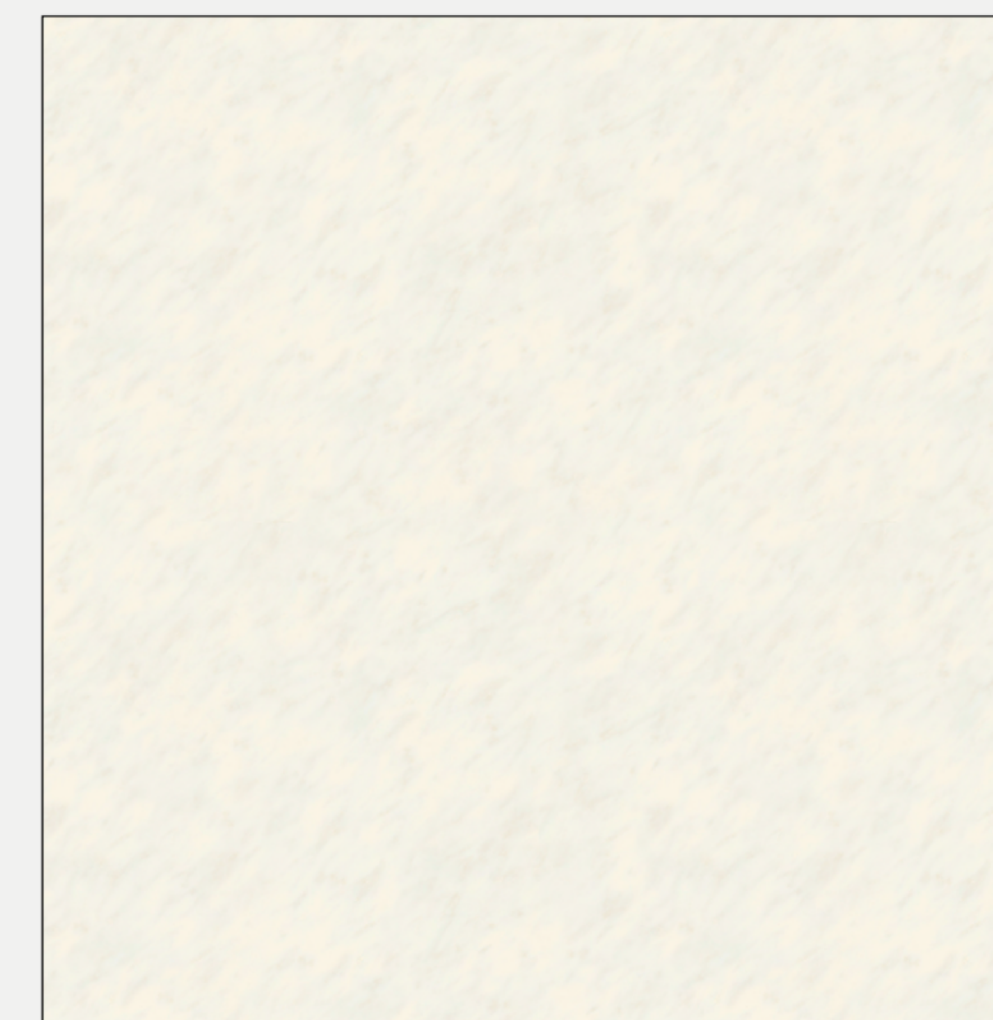

Pozzetti counter top in Silestone®

Dim: **W**x**L**x**H**

inch: **40,1** x **67** x **37**

cm: **102** x **170** x **94**

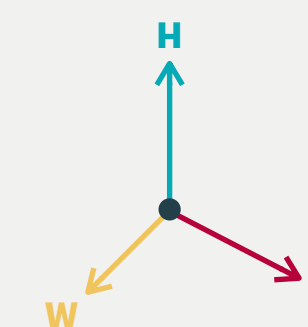

7 - BACK COUNTER COFFEE MACHINE

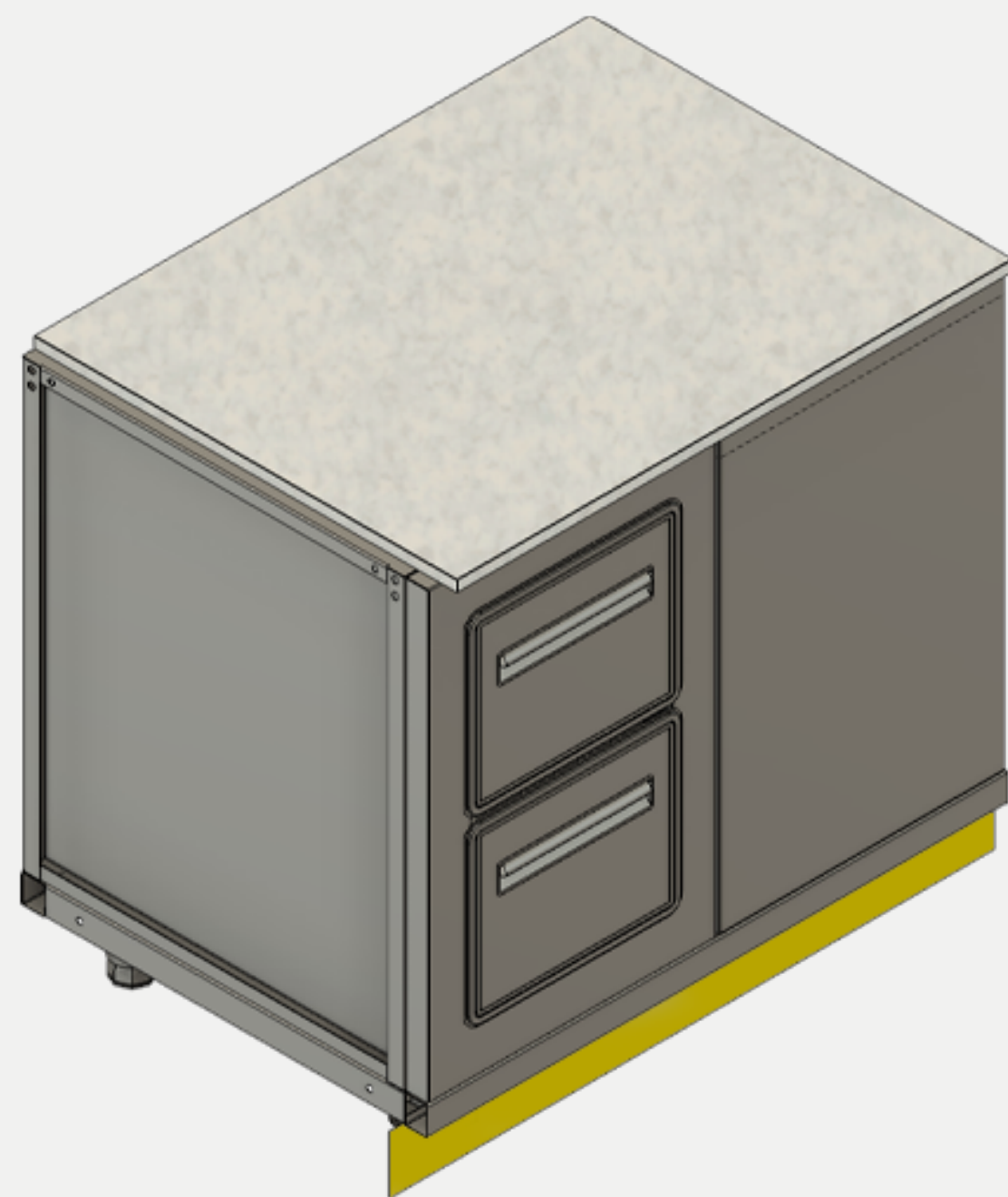

- Stainless steel frame
- 1 Stainless steel Cabinet doors
- 2 coffee drawer
- 2 Stainless steel shelves
- Plinth coated made galvanized steel

The coffee machine back counter, made entirely of stainless steel with a stainless steel door, is designed to ensure durability, hygiene, and everyday practicality. Equipped with **two hoppers for coffee preparation**, it offers an efficient and functional solution for industry professionals. The **Silestone® Cosentino** surfaces ensure long-lasting performance, easy cleaning, and a refined look—ideal even for areas visible to customers.

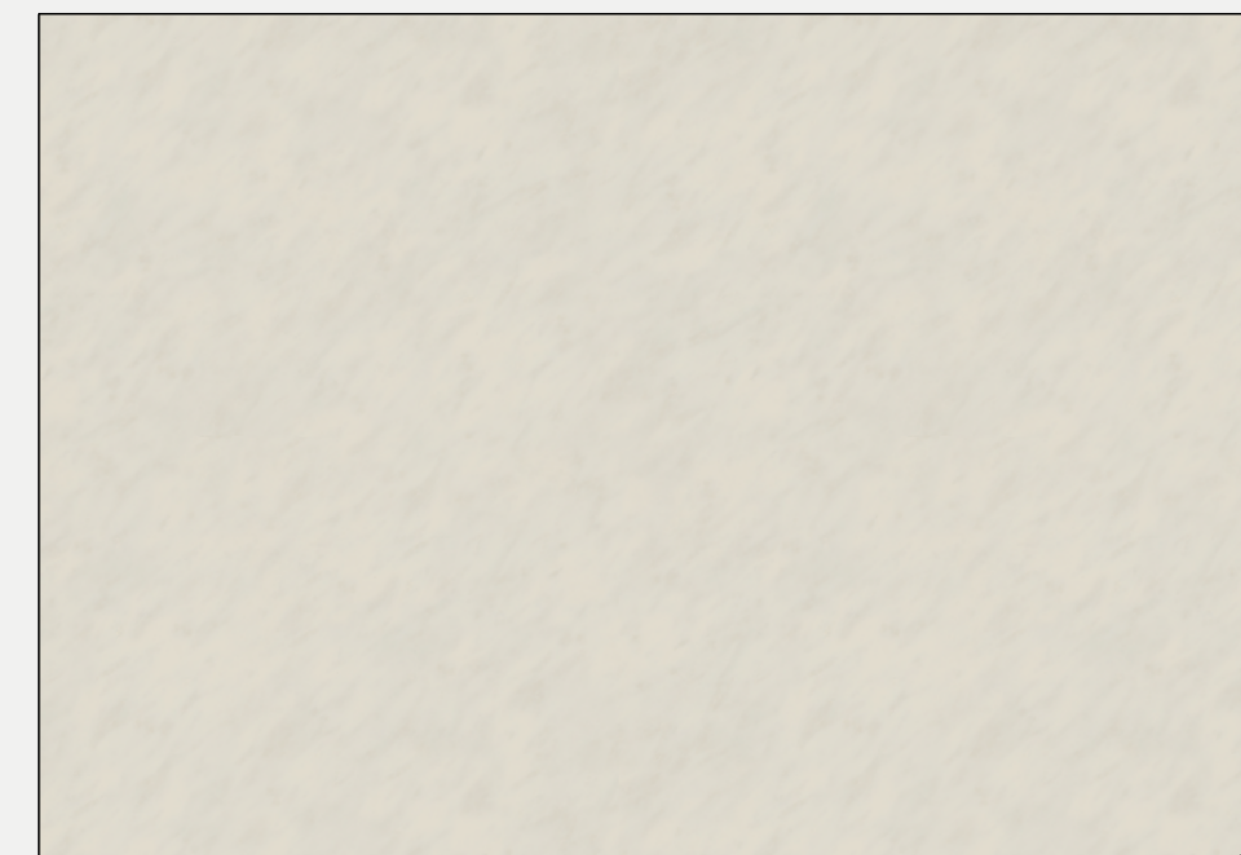

Pozzetti counter top in Silestone®

Dim: **W**x**L**x**H**

inch: **28,7** x **37,8** x **37**

cm: **73** x **96** x **94**

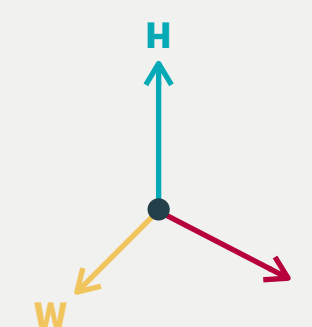



8 - NEUTRAL COUNTER

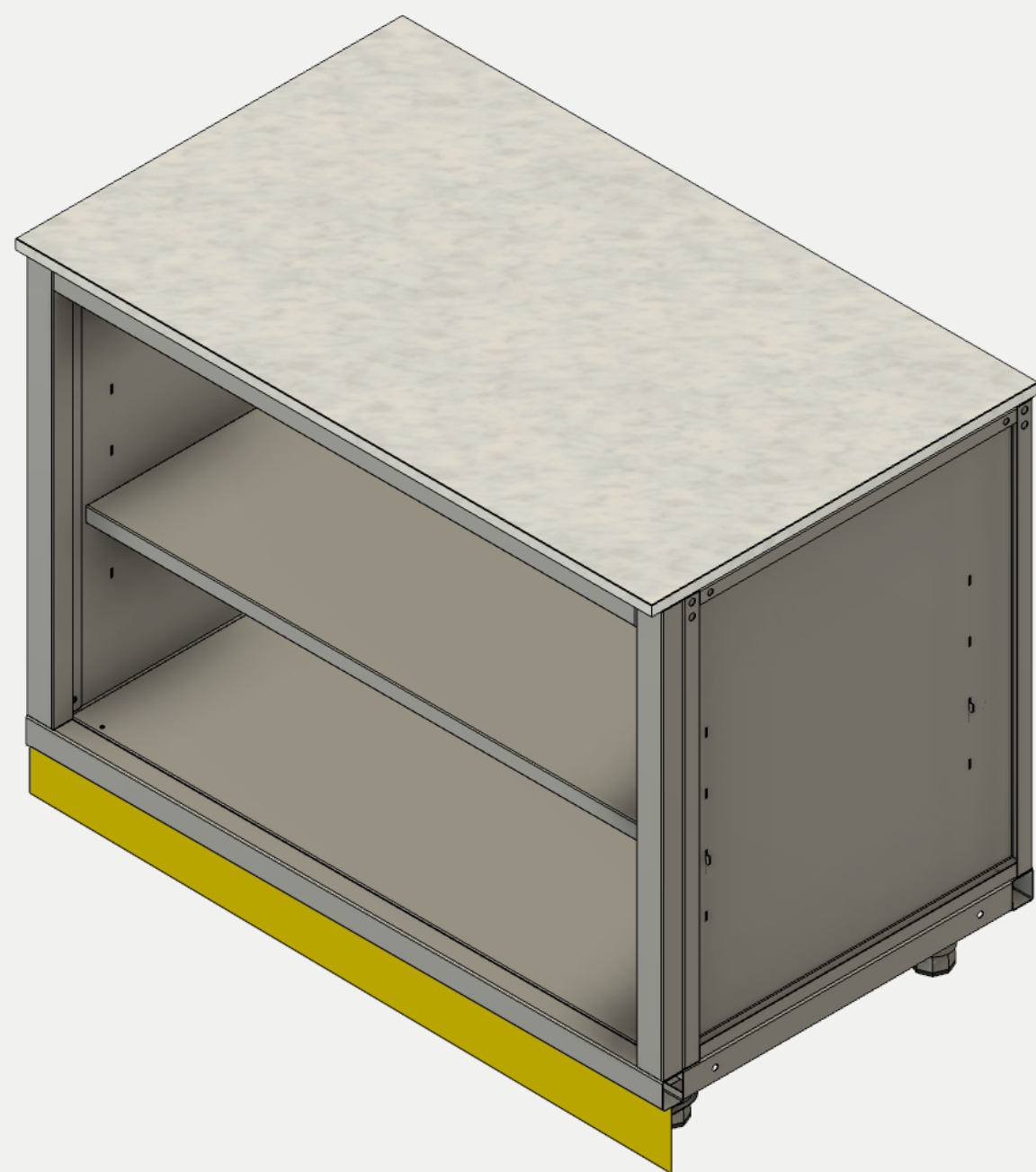

- Stainless steel frame
- 1 Stainless steel drawer
- 2 Stainless steel shelves
- Front panels made galvanized steel
- Plinth coated made galvanized steel

The neutral counter, with a **fully stainless steel frame**, is designed to ensure efficiency and organization in any operational setting. Equipped with **large stainless steel shelf, (or tailor made lay out)** it offers a durable, hygienic, and functional solution for space management. The Silestone® Cosentino surface guarantees long-lasting performance and easy cleaning, while the **front panels**, made of powder-coated galvanized steel with **high-resistance finishes**, complete the structure by combining strength with essential aesthetics.

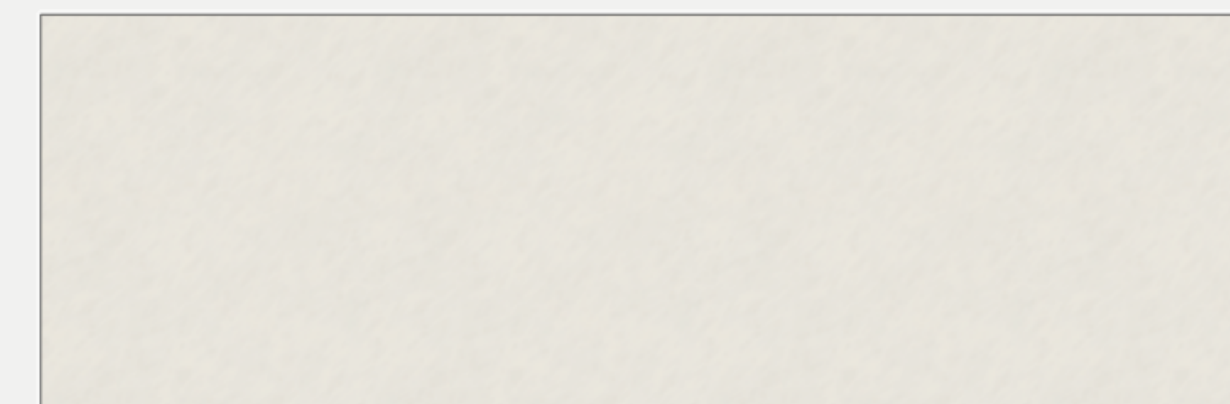

Pozzetti counter top in Silestone®

Dim: **W**x**L**x**H**
inch: **40,1** x **47,2** x **37**
cm: **102** x **120** x **94**

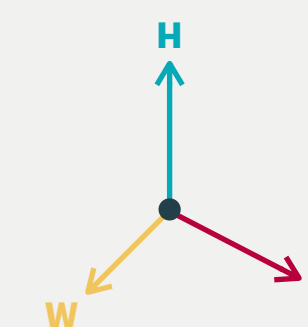

9 - BACK COUNTER SINK



- Stainless steel frame
- 2 Stainless steel Cabinet doors
- Stainless steel sink and tap
- 2 Stainless steel doors
- Plinth coated made galvanized steel

The professional **sink unit**, with a **fully stainless steel frame and doors**, is designed to ensure durability and functionality in demanding work environments. Equipped with a **large sink** and **professional faucet**, it combines practicality and ease of use while remaining **elegant and visually appealing to the public**. The Silestone® Cosentino surface guarantees durability and easy cleaning

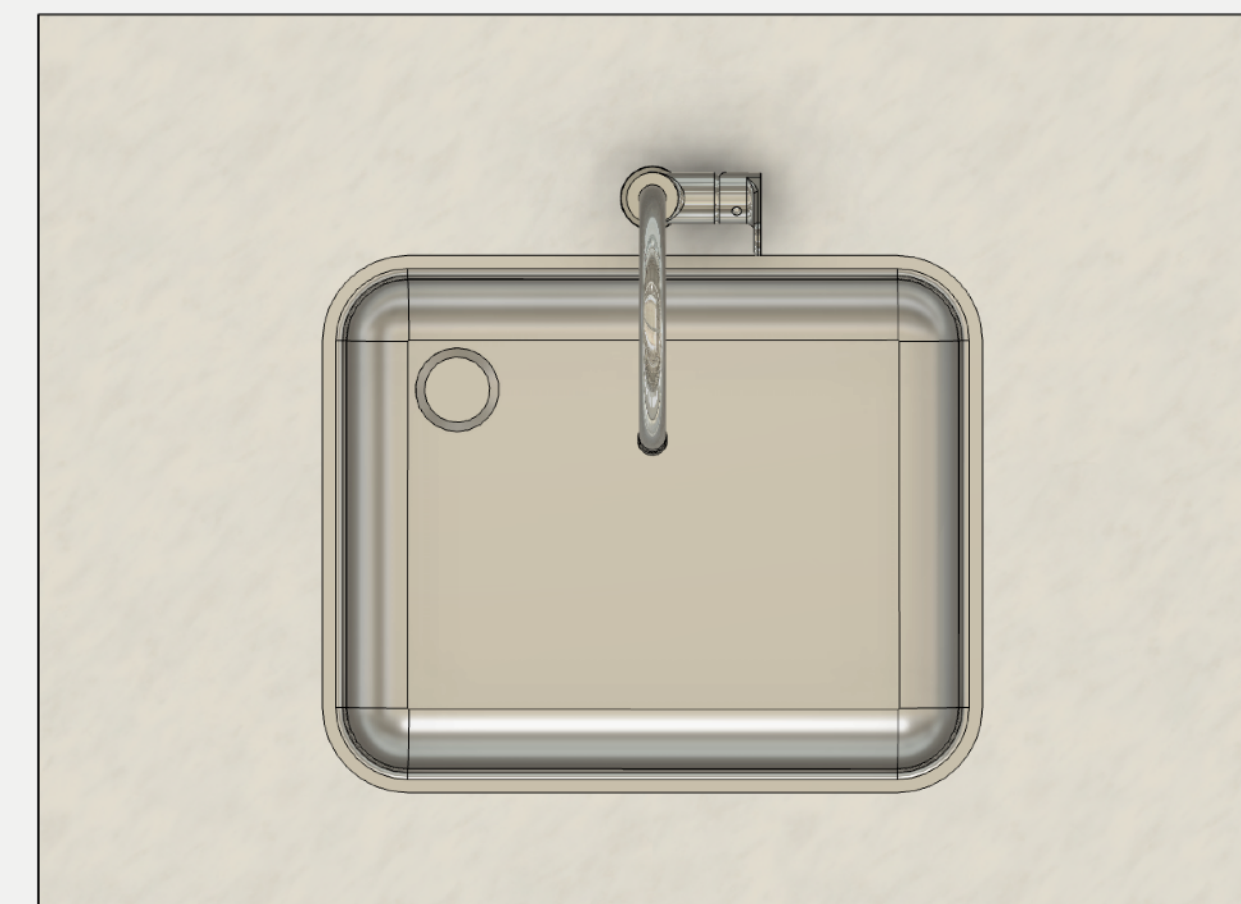



Pozzetti counter top in Silestone®

Dim: **W**x**L**x**H**

inch: **28,7** x **39,3** x **37**

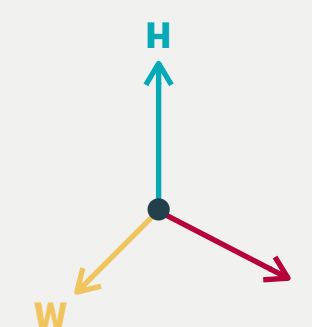
cm: **73** x **100** x **94**



 10 - BACK COUNTER 3 DOORS REFRIGERATED

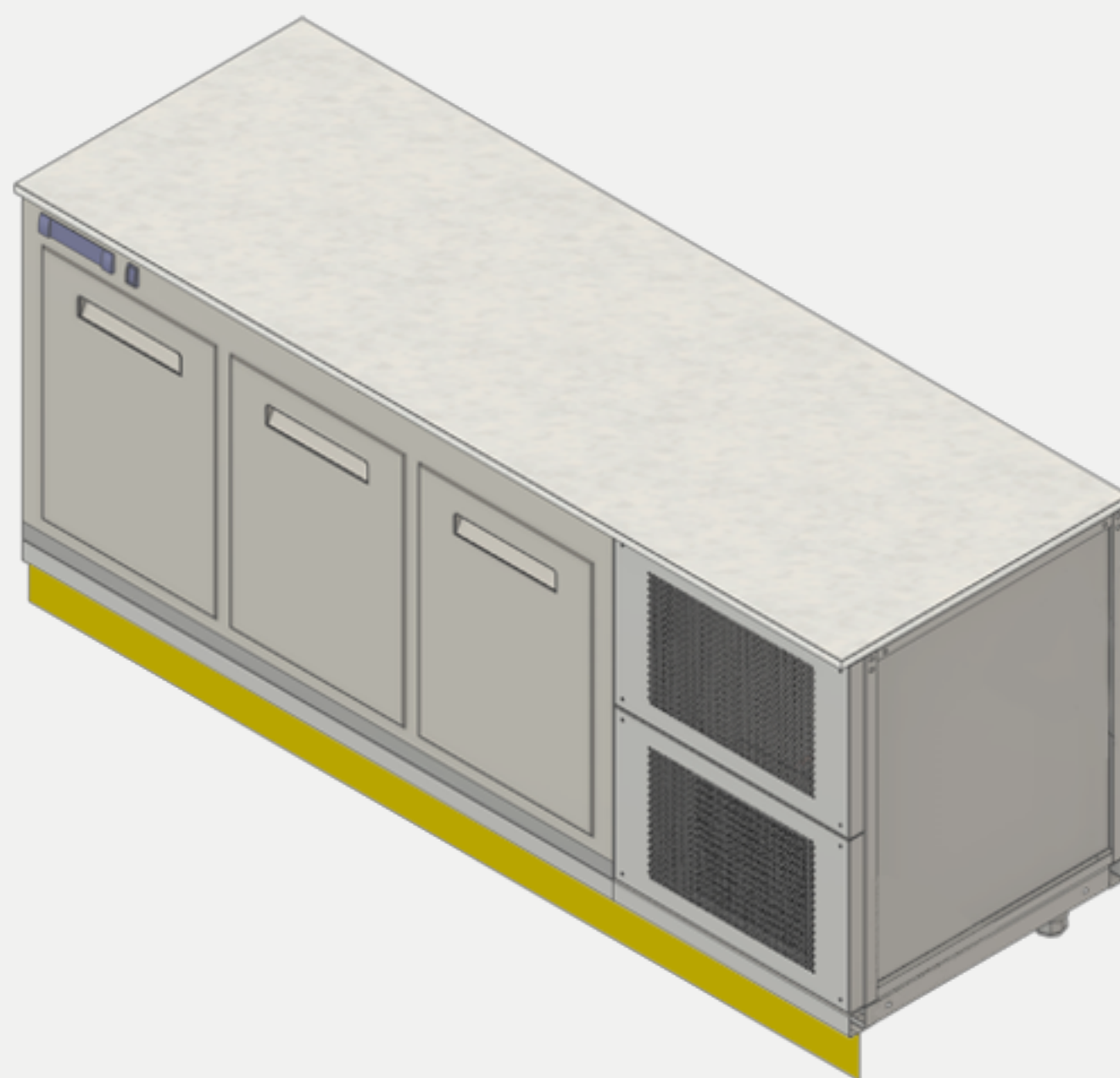

- Stainless steel frame
- 3 Doors refrigerated cabinet
- compressor unit
- Plinth coated made galvanized steel

The refrigerated cell, with a fully stainless steel structure, is designed to ensure maximum hygiene, durability, and reliability. Equipped with an **on-board refrigeration unit**, it provides precise temperature control in all operating conditions. The **Silestone® Cosentino** surface completes the system, offering high durability and easy cleaning.

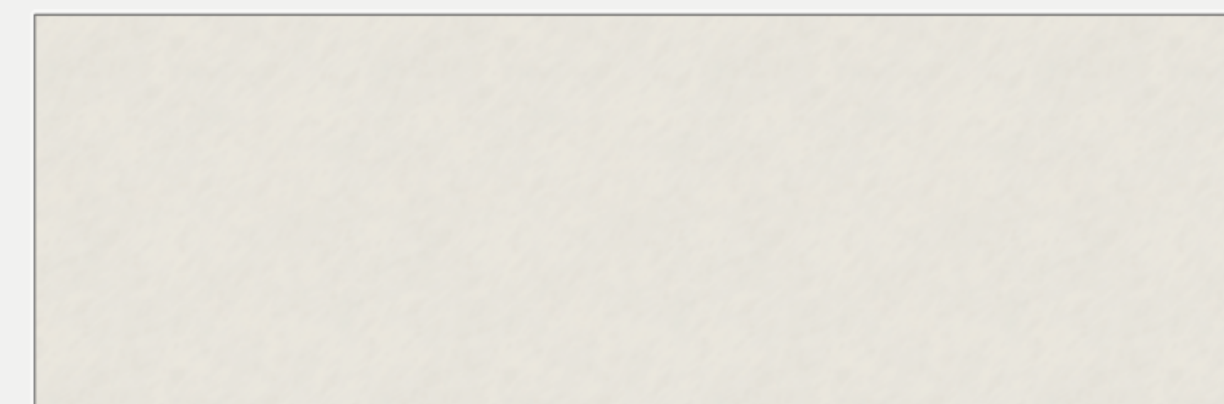

Pozzetti counter top in Silestone®

Dim: **W**x**L**x**H**

inch: **28,7** x **82,6** x **37**

cm: **73** x **210** x **94**

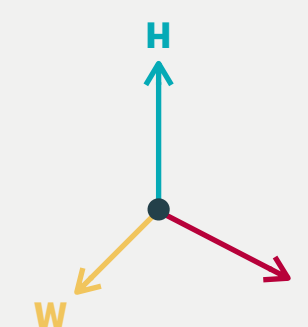

11 - BACK POZZETTI COUNTER

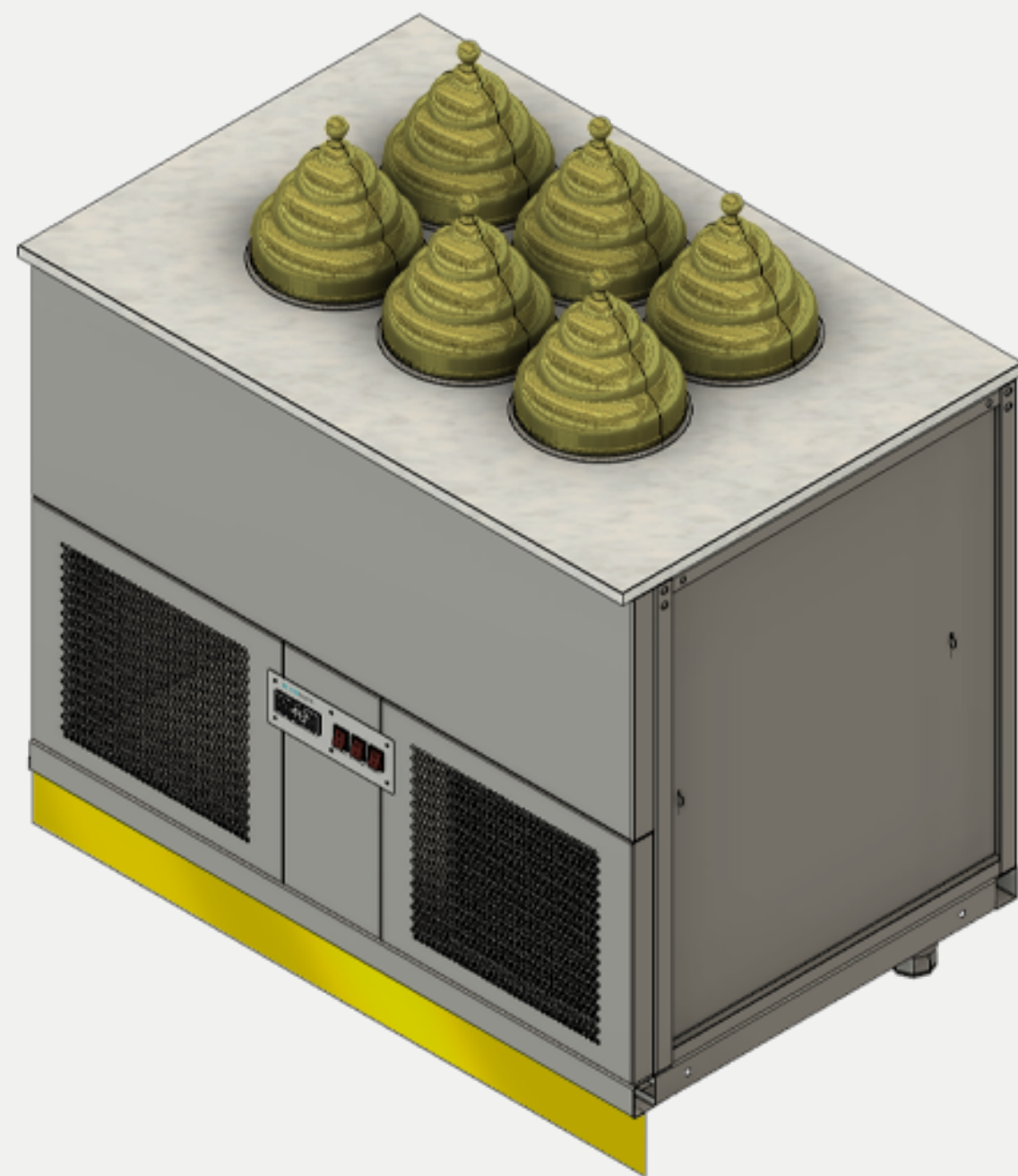

- Stainless steel frame
- 1 Stainless steel drawer
- 6 golden tubs 24-carat
- Front panels made stainless steel
- compressor unit

The **pozzetti counter with glycol refrigeration system**, developed by Tekneitalia over 15 years ago, is a reliable and efficient solution for gelato preservation. Thanks to the high performance of its refrigeration circuit, it ensures low energy consumption and constant temperature control, making it ideal for overnight storage without compromising product quality.

With a **load capacity of 30 kg (6 flavors)**, it features a **professional control system** for precise temperature management and **integrated refrigeration units**. The **Silestone[®] Cosentino** surface guarantees durability and easy cleaning, while the front panels in **painted galvanized steel** with high-resistance finishes complete the structure, combining robustness with essential aesthetics.

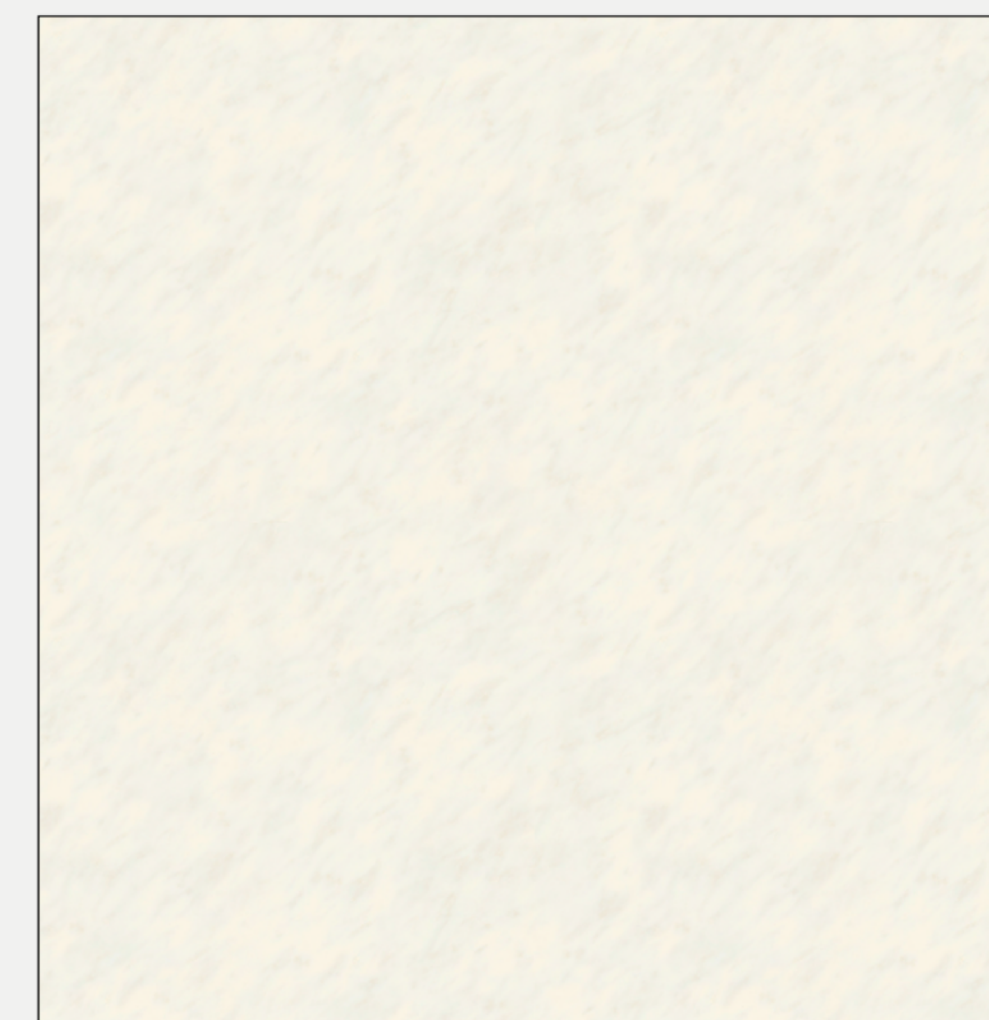

Pozzetti counter top in Silestone[®]

Dim: **W**x**L**x**H**
inch: **40,1** x **43,3** x **37**
cm: **102** x **110** x **94**

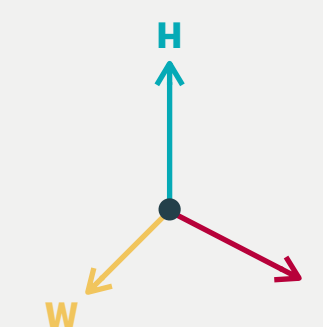

12 - BACK COUNTER SINK



- Stainless steel frame
- 2 Stainless steel Cabinet doors
- Stainless steel sink and tap
- 2 Stainless steel doors
- Plinth coated made galvanized steel

The professional **sink unit**, with a **fully stainless steel frame and doors**, is designed to ensure durability and functionality in demanding work environments. Equipped with a **large sink** and **professional faucet**, it combines practicality and ease of use while remaining **elegant and visually appealing to the public**. The Silestone® Cosentino surface guarantees durability and easy cleaning

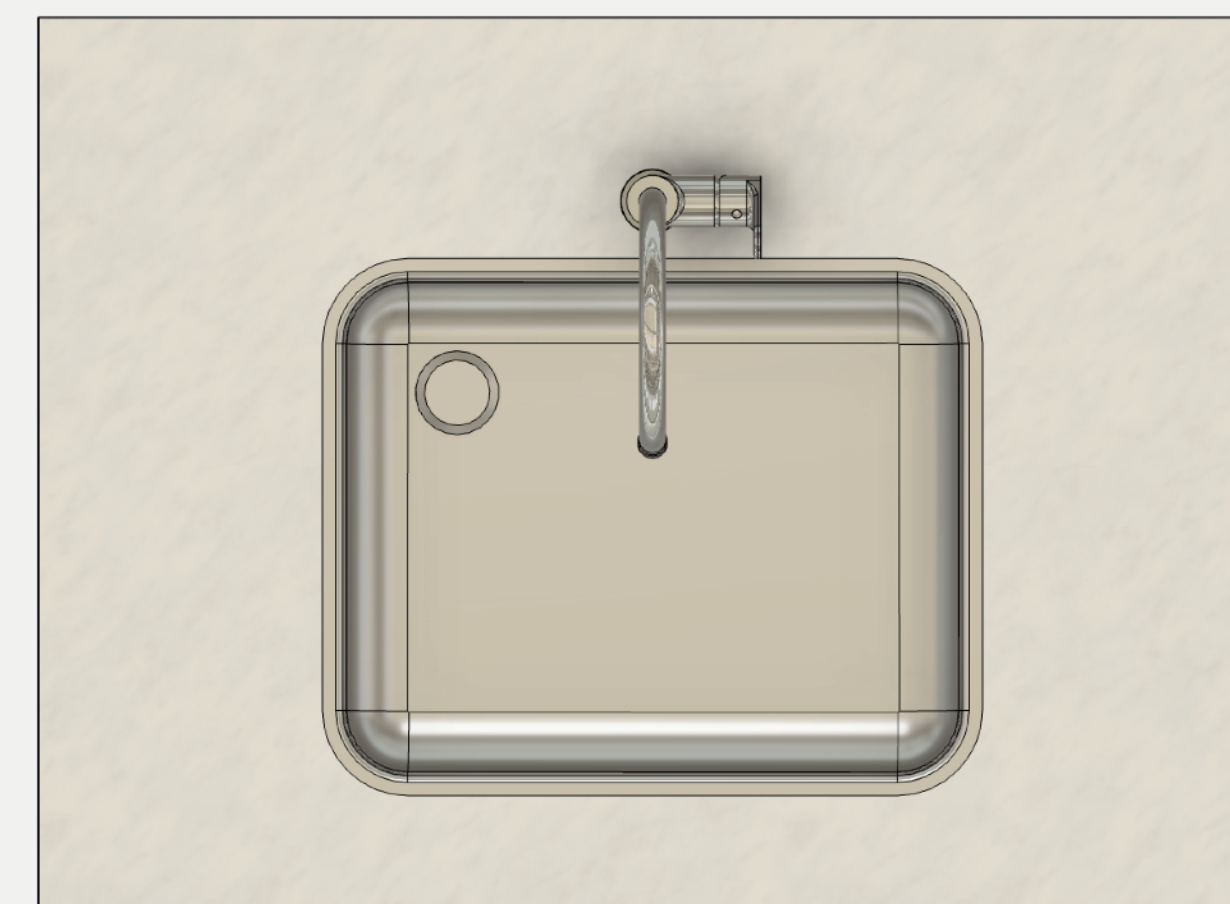

Pozzetti counter top in Silestone®

Dim: **W**x**L**x**H**
inch: **28,7** x **39,3** x **37**
cm: **73** x **100** x **94**

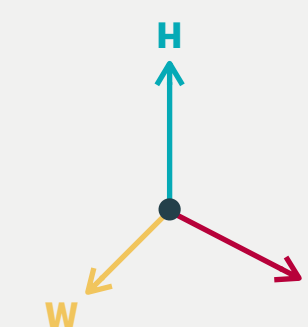



13 - NEUTRAL COUNTER

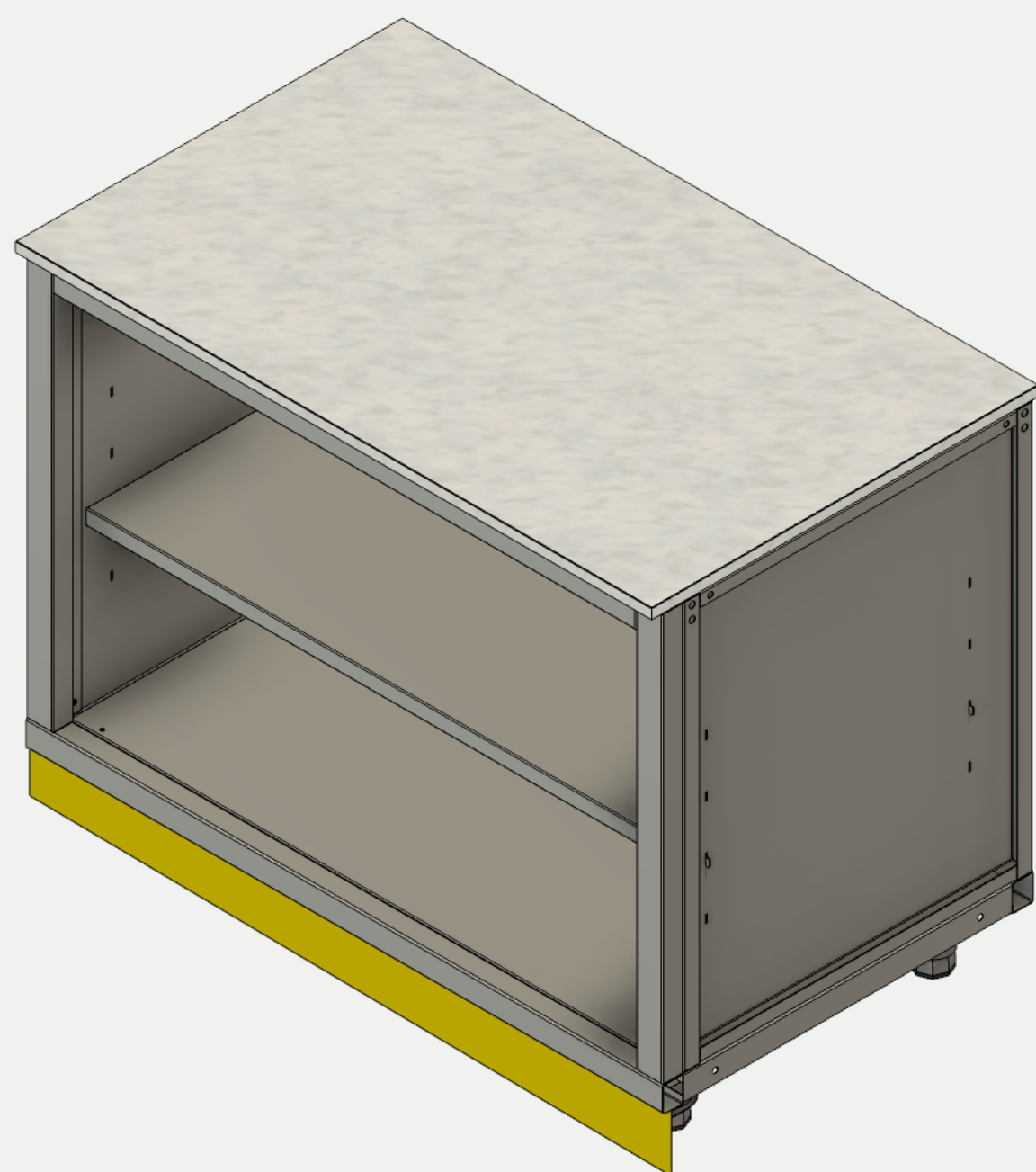

- Stainless steel frame
- 1 Stainless steel drawer
- 2 Stainless steel shelves
- Front panels made galvanized steel
- Plinth coated made galvanized steel

The neutral counter, with a **fully stainless steel frame**, is designed to ensure efficiency and organization in any operational setting. Equipped with **large stainless steel shelf, (or tailor made lay out)** it offers a durable, hygienic, and functional solution for space management. The Silestone® Cosentino surface guarantees long-lasting performance and easy cleaning, while the **front panels**, made of powder-coated galvanized steel with **high-resistance finishes**, complete the structure by combining strength with essential aesthetics.

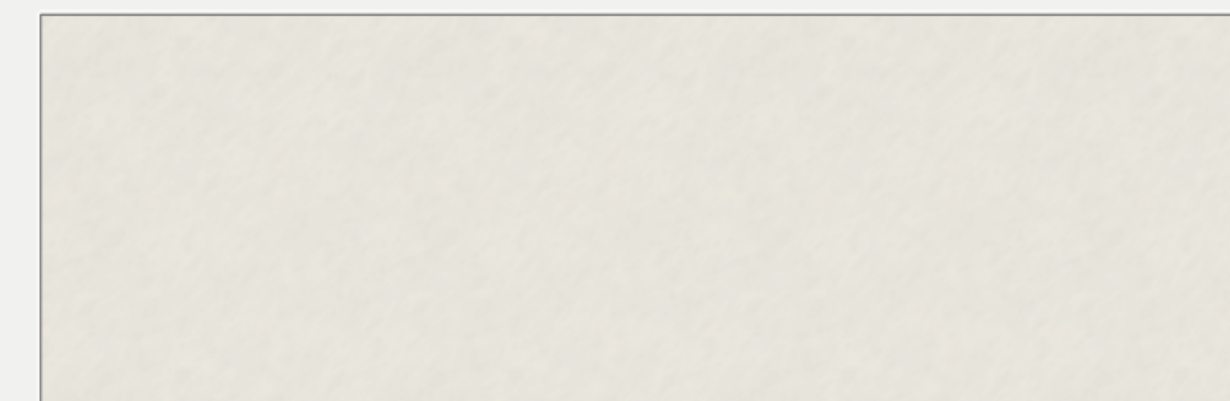

Pozzetti counter top in Silestone®

Dim: **W**x**L**x**H**

inch: **40,1** x **78,7** x **37**

cm: **102** x **200** x **94**

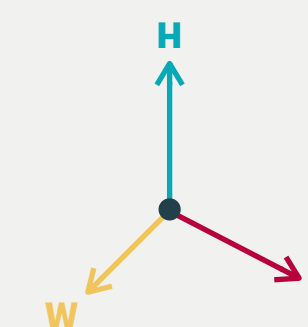



SPLASH GUARD

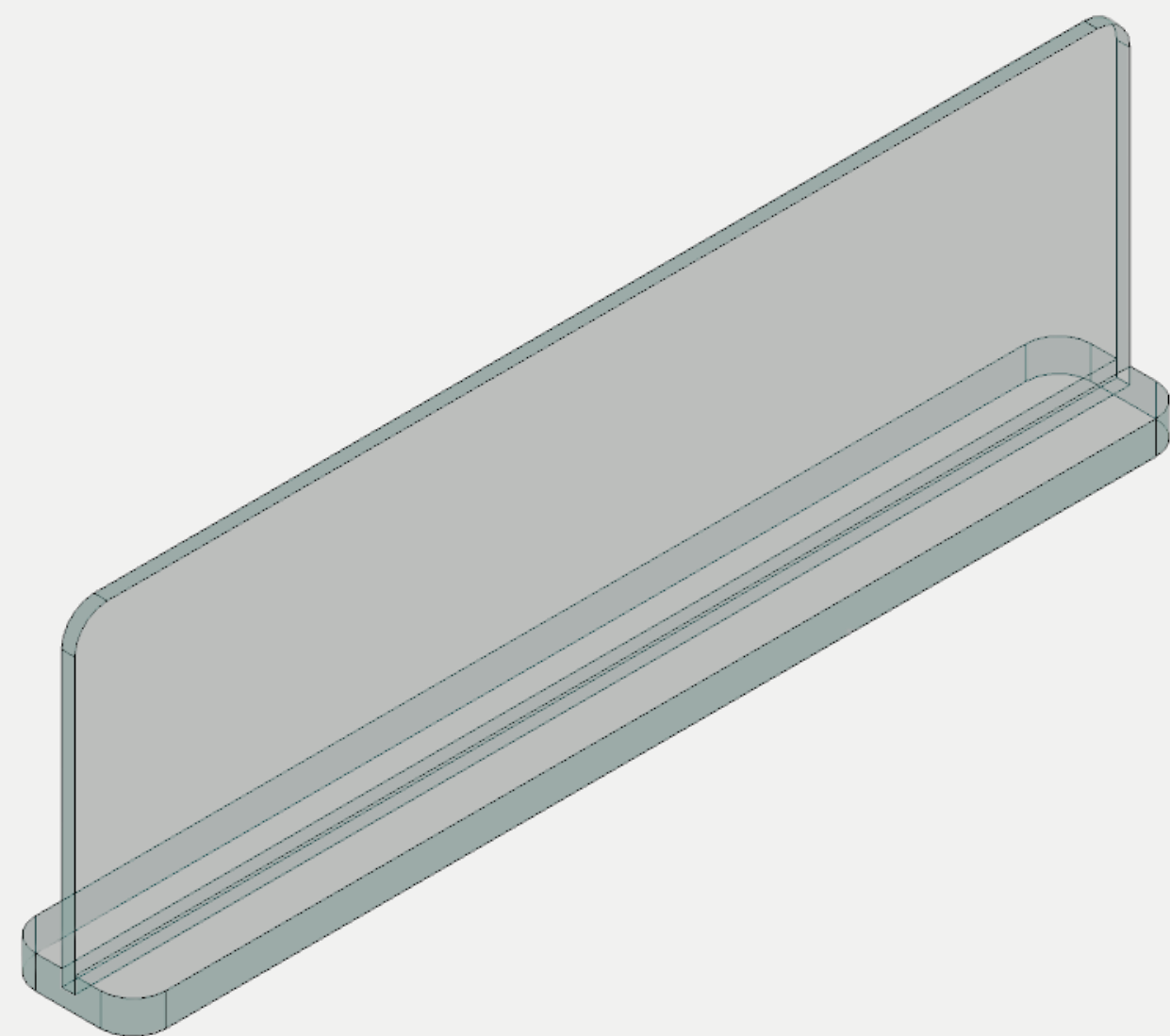

-N2 Splash Guard

Transparent polycarbonate splash guard

Provides safe protection while keeping the work area clean, without compromising the aesthetic of the space thanks to its transparency and discreet design.

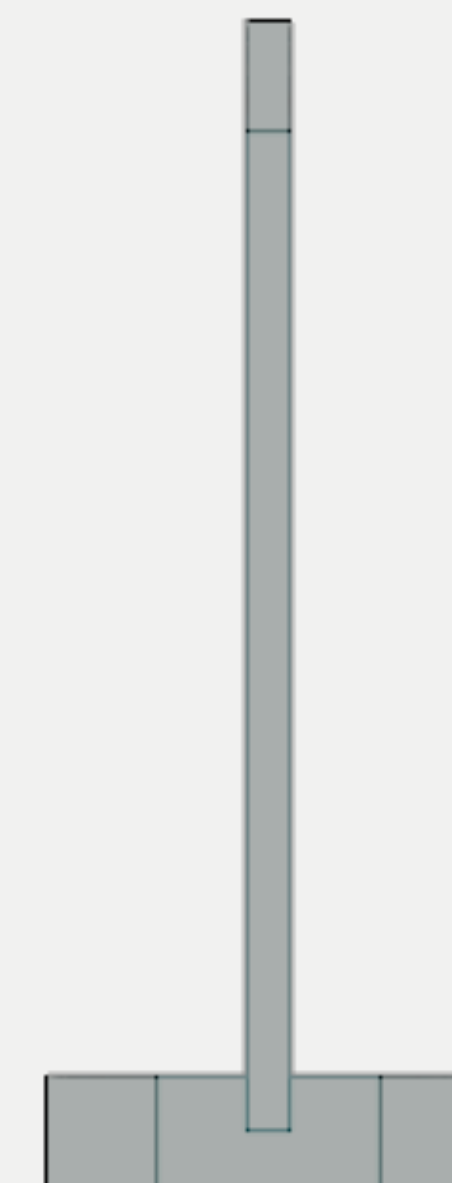

Polycarbonate

Dim: **W**x**L**x**H**

inch: **27,5** x **4,7** x **8,7**

cm: **70** x **12** x **22**

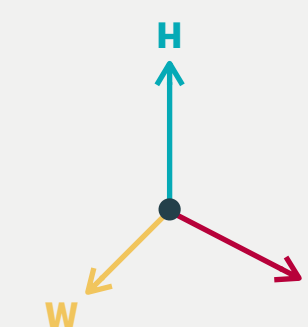



I RIVESTIMENTI: I PIANI

silestone®

By COSENTINO®

A leading brand for over 30 years that inspires designs for kitchens, bathrooms and commerciale surfaces.

25 Years warranty
Hybrid mineral surfaces to create innovative spaces that endure over the time.

Advantages and properties



Elevata resistenza ai graffi
l'uso e l'usura quotidiana non graffiano Silestone.

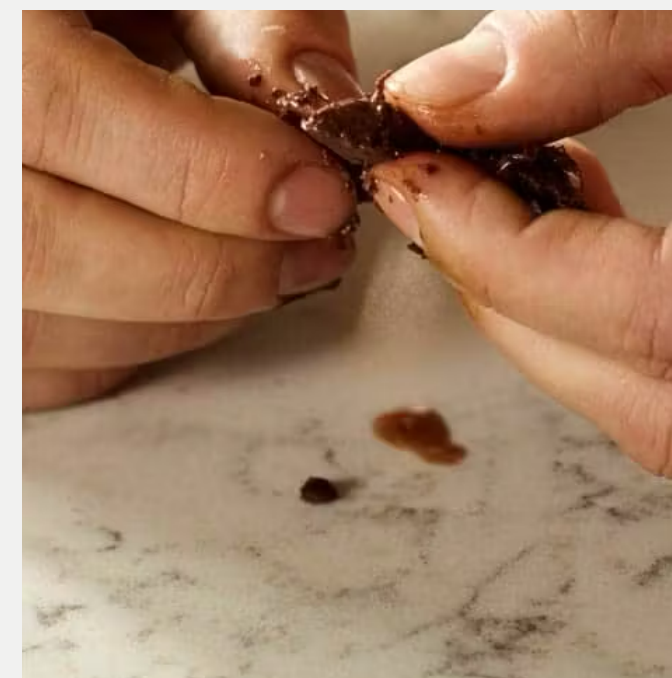

Elevata resistenza alle macchie
La bassa porosità li rende altamente resistenti alle macchie.



Alta resistenza agli urti
Altamente resistente agli impatti quotidiani.

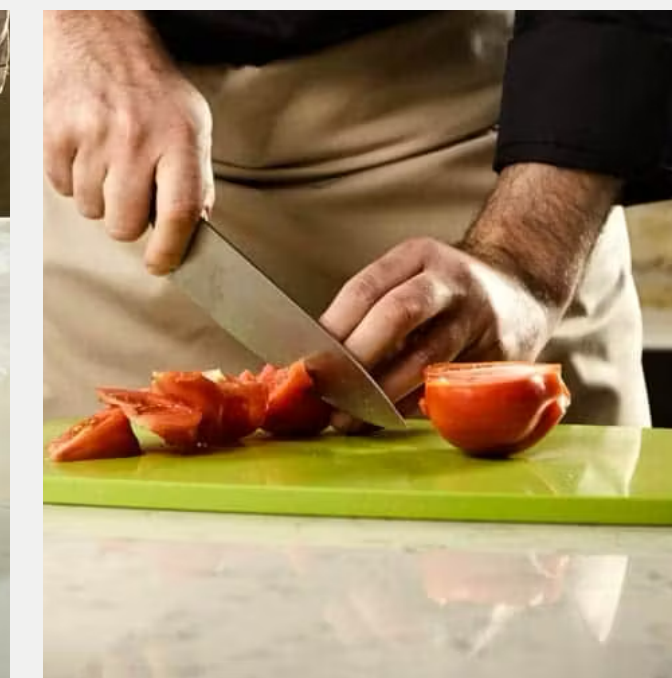

Elevata resistenza agli acidi
La bassa porosità gli impedisce di essere danneggiato da macchie aggressive.

Finish



Polished
More vibrant and intense colors and reflections

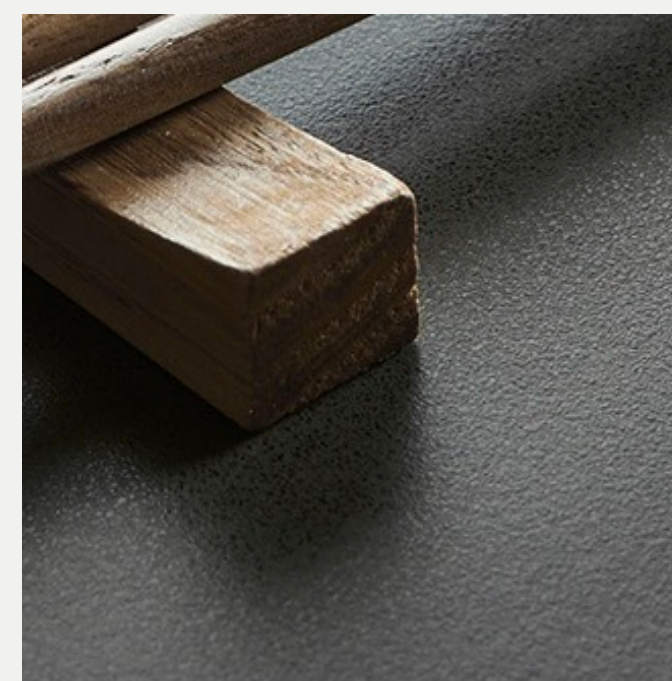

Suede
Soft and pleasant feel with full color consistency

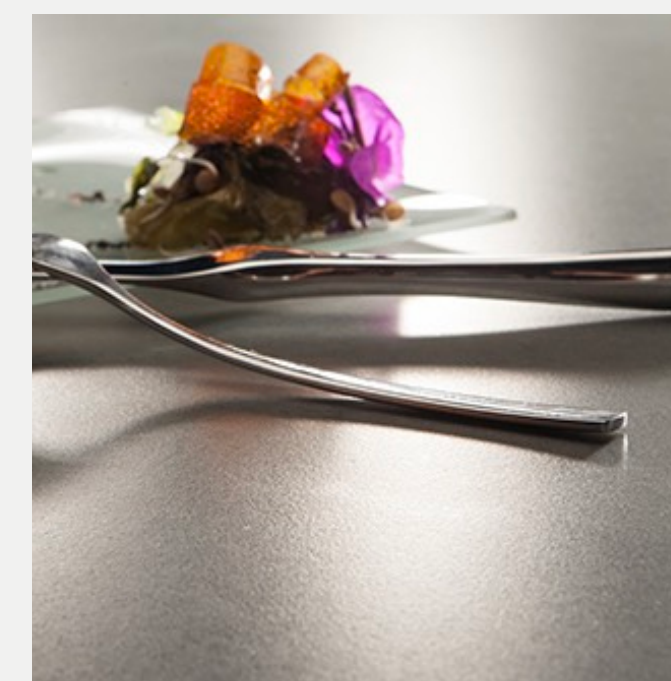

Mate
Solid and satin color

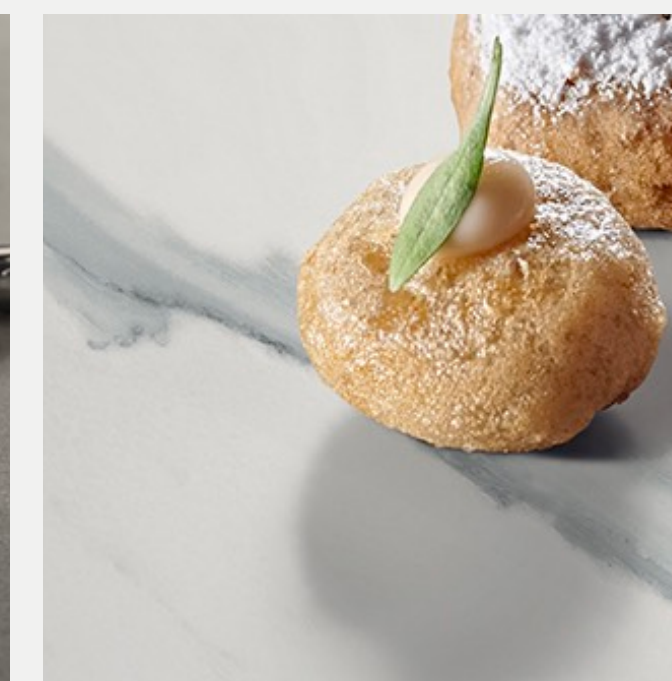

Velvet

Maintenance



Click the colors to see them in use

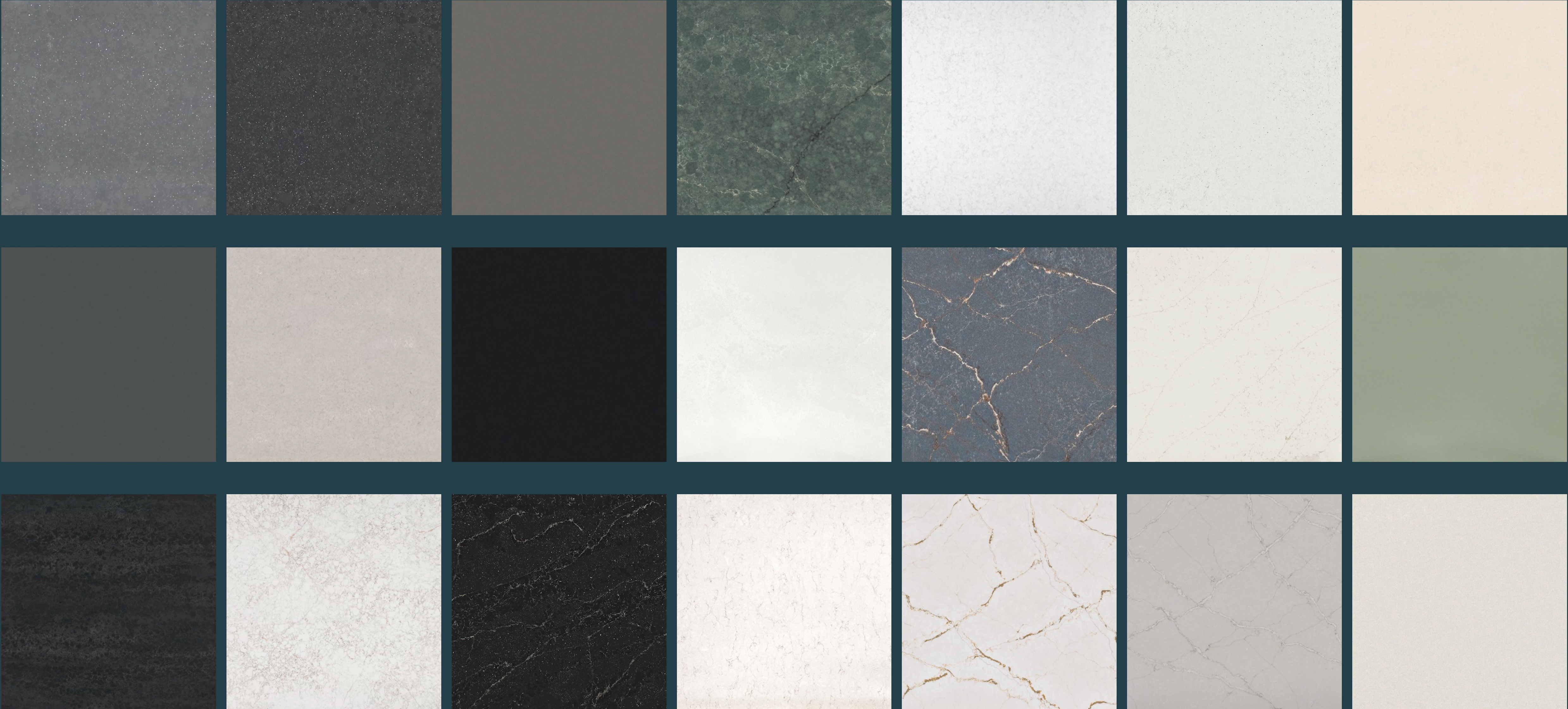

 **COLORS WITHOUT LIMITS**



[RAL Chart](#)

PANTONE®

[Pantone Chart](#)

kerakoll

[Kerakoll Chart](#)

With TekneItalia, you're never confined to a preset color palette. **We offer access to thousands of colors** through internationally recognized systems like **RAL** and **PANTONE***, ensuring your customization is truly **limitless**. Whatever shade you envision, we can bring it to life—without compromises and without boundaries.

 **COLORS WITHOUT LIMITS**

3M

DI-NOC™

3M™ DI-NOC™ Architectural E-Series PO Polyolefin Film are film surface finishes that give you a range of choices as you pursue your sustainability goals. These films are made with approximately 99.5% non-PVC (non-vinyl) materials, and do not contain more than 0.5% of a polyvinyl chloride-based component. **These finishes are available in various patterns and textures – wood, plaster, concrete and more, and are a great way to upgrade your interior look without all the disruption.** 3M™ Comply™ Adhesive technology virtually eliminates air bubbles, simplifying and speeding up the application process.



Catalogue 3M Di - NOC



TOTAL CUSTOMIZATION

With TekneItalia, every piece of furniture becomes a **unique expression of your brand**. **Integrated “under-surface” digital graphics, stencil techniques, and glossy or matte finishes are just some of the available options.** Thousands of combinations of materials, colors, and details allow you to create truly tailor-made solutions, with no limits to customization.





PROMINENT DETAILS

Laser-engraved details add depth and personality to the furniture, with the option to be painted or finished with an elegant 24-carat gold plating. **Custom-made**, these exclusive elements transform any space, making your venue unique and **instantly recognizable**.



THIS IS A **TEKNEITALIA**® PROJECT

Tekneitalia is a company founded **over 15 years ago** with the clear and ambitious goal of revolutionizing the way business is done in the HO.RE.CA. sector. Through **carts and mobile devices with iconic and highly recognizable design**, we have made **beauty a tool for work**. From day one, our mission has been to offer clients **not only functional tools but true extensions of their identity**: objects capable of expressing **values, emotions**, and visions through a refined and **timeless aesthetic**.

TEKNEITALIA®
Brows our website



TEKNEITALIA®

 **YOUR PROJECT, GUIDED BY EXPERT**

A dedicated team of **architects and graphic designers** will support you at every stage of development, working closely with you to create the best version of your project. Thanks to 3D modeling in a virtual environment, you'll be able to explore every detail of your venue before implementation, choosing each element with precision and ensuring a flawless result.

Contact us and **share your needs** to discover how we can **turn your project into reality**. Receive detailed information and a personalized quote, with **no obligation**.

INFO@TEKNEITALIA.COM

MOBILE OFFICE: +39 328 221 34 74

MOBILE SALES EXPORT: + 39 366 421 23 63

TEKNEITALIA USA: +1 212 810 6725