

 SHOP SIZE- 20 SQM/215 SQF

# PASTRY SHOP





The **French pastry** shop, located within the airport **food court**, reflects the brand's identity through furnishings that translate its **aesthetic and functional values**. In a fast-paced, “**grab-and-go**” context, the space stands out for its **immediate recognizability**: the Art Deco-inspired pattern and logo become key identity elements that capture attention and convey the brand's elegance. Coherent materials, colors, and geometries create a refined and contemporary environment, combining operational efficiency with a **strong visual** presence within the airport setting.

























## VIRTUAL TOUR

Discover our virtual environments: **explore in 3D the spaces designed for you**, experience immersive engagement, and make confident decisions. **Find the right inspiration** to create a tailor-made, innovative, and unique venue.



Virtual Tour



## MOODBOARD

Every detail of the interior tells the **story of the brand**, where the memory of **Art Deco** intertwines with a sense of **contemporary elegance**. The brand's **signature blue** takes center stage, blending with light surfaces and metallic reflections to create a refined, timeless atmosphere. Along the walls, alternating **blue and white stripes** evoke the charm of a small **tea room from another era**, reinterpreted with a modern eye to attract, welcome, and stand out. A space that celebrates the tradition of **French pastry** with **modern lightness** and **impeccable taste**.

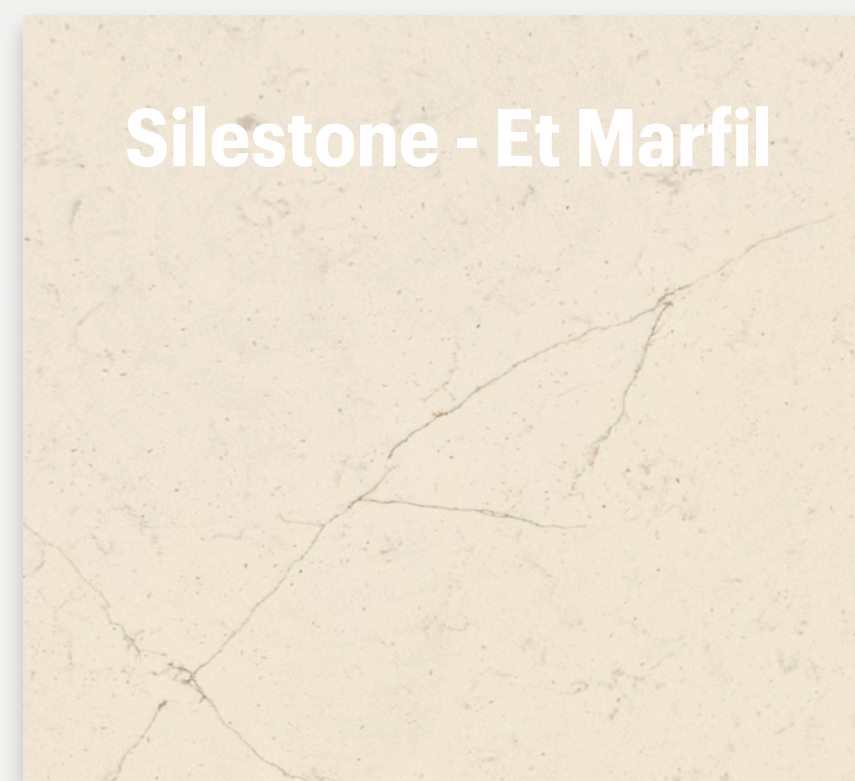

Silestone - Et Marfil

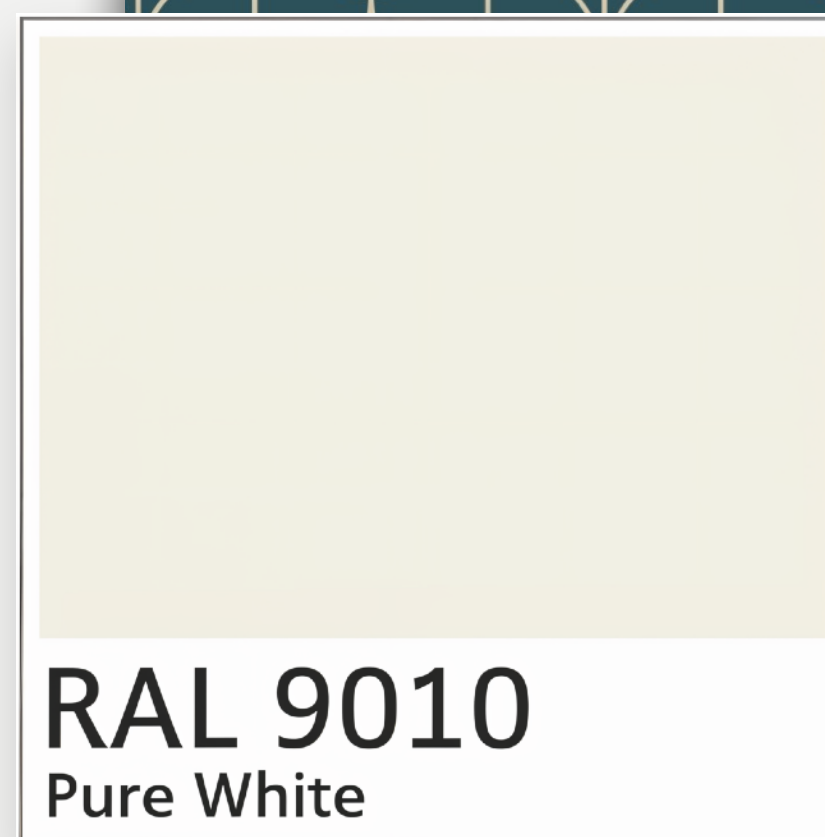

RAL 9010  
Pure White





## FLOOR PLAN

The layout is designed to meet the **needs of a high-traffic** airport environment. The space allows for **quick and efficient service**, with **dedicated areas for packaging gift items** — products conceived to be easily purchased and carried along the journey.

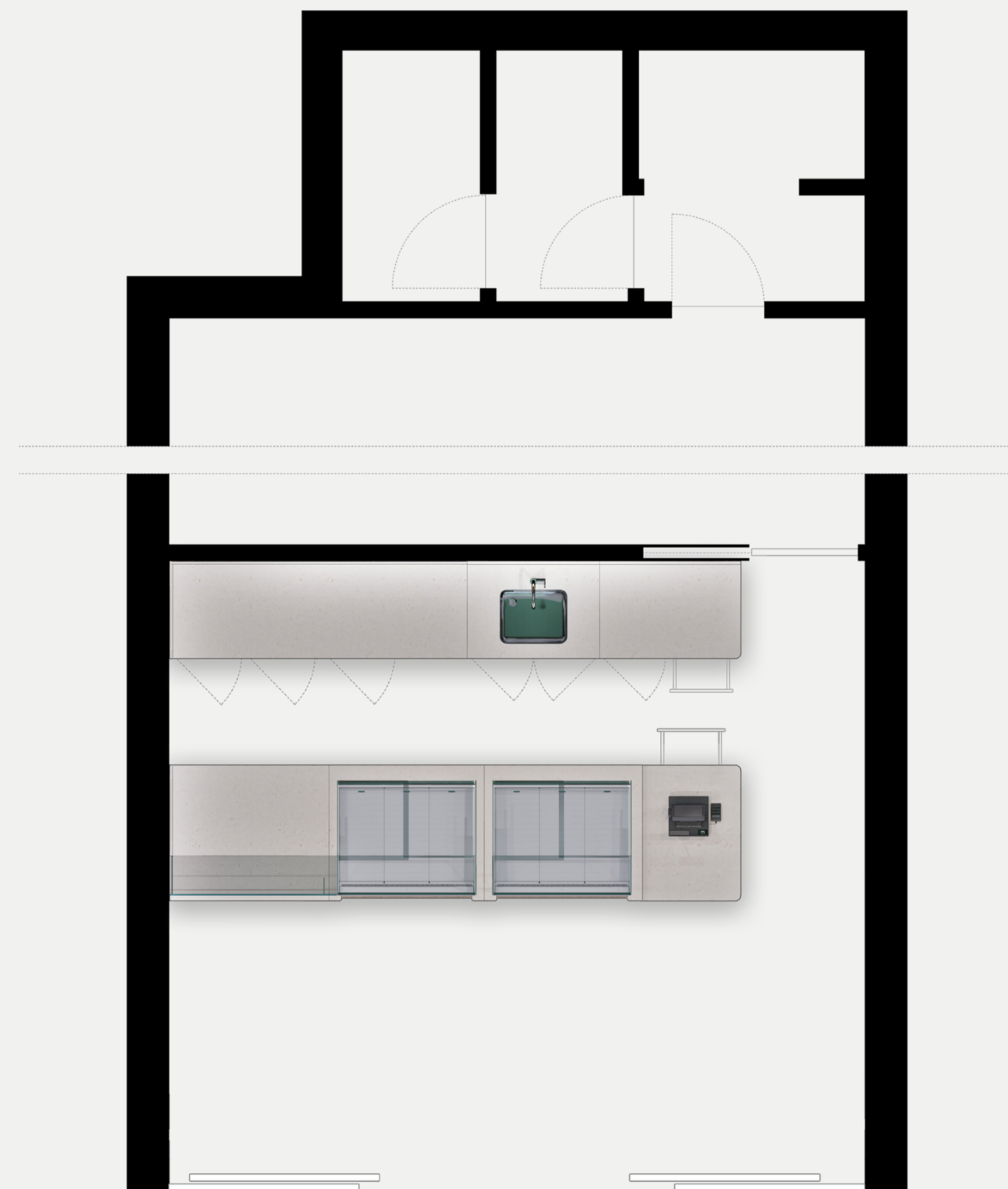



## LAY-OUT

In just **215 sqf**, the design makes the most of every inch, **creating a functional and distinctive space**. The display area invites customers to explore and **enjoy the products** on the spot, while the **refrigerated pastry display case**, designed at an **inclusive height**, welcomes children and wheelchair users alike. Every element of the interior is crafted to showcase the products in their packaging, **turning the small pastry shop into an experience of discovery and quality**, where every detail reflects care and style.

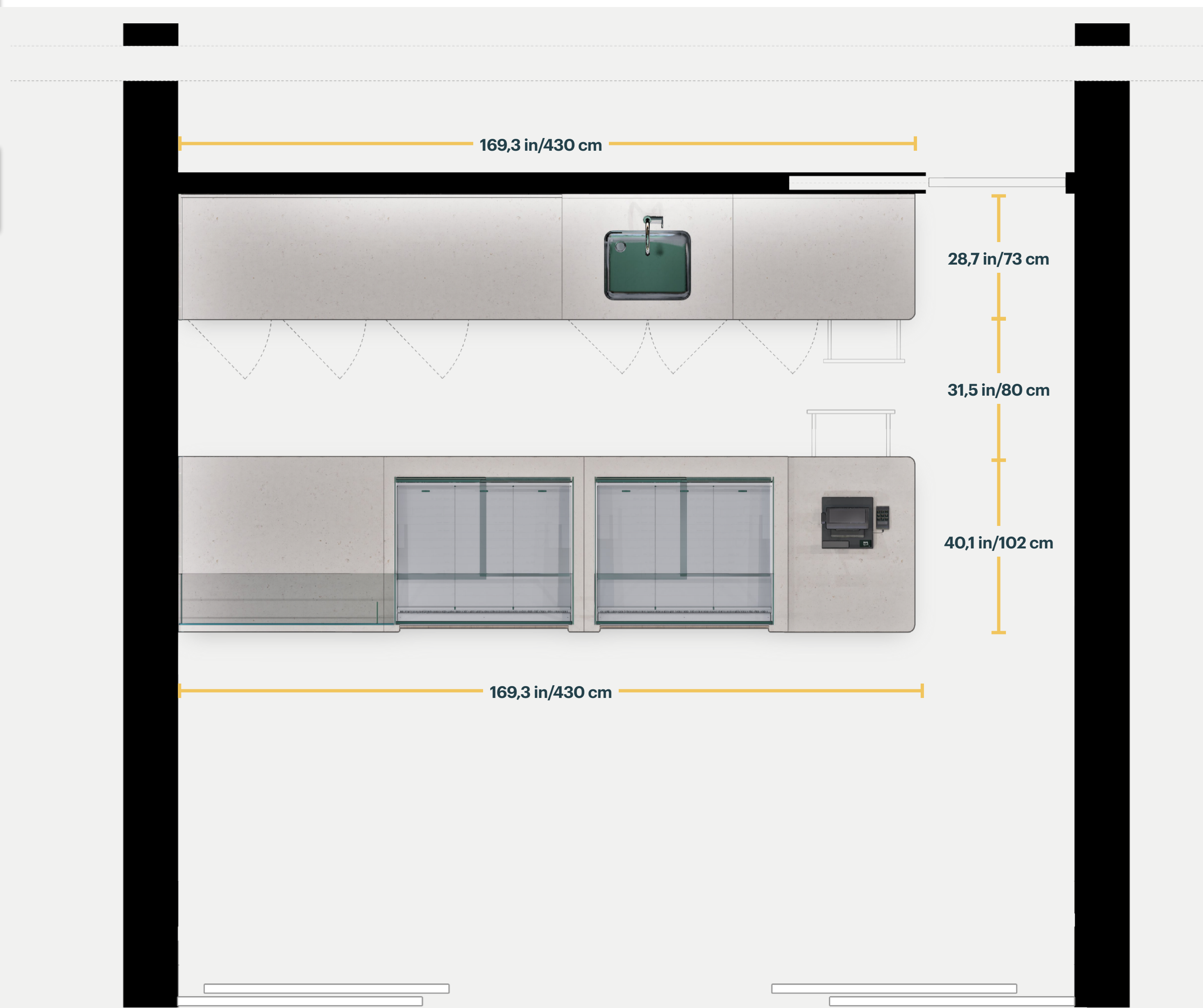

## FURNITURE LIST

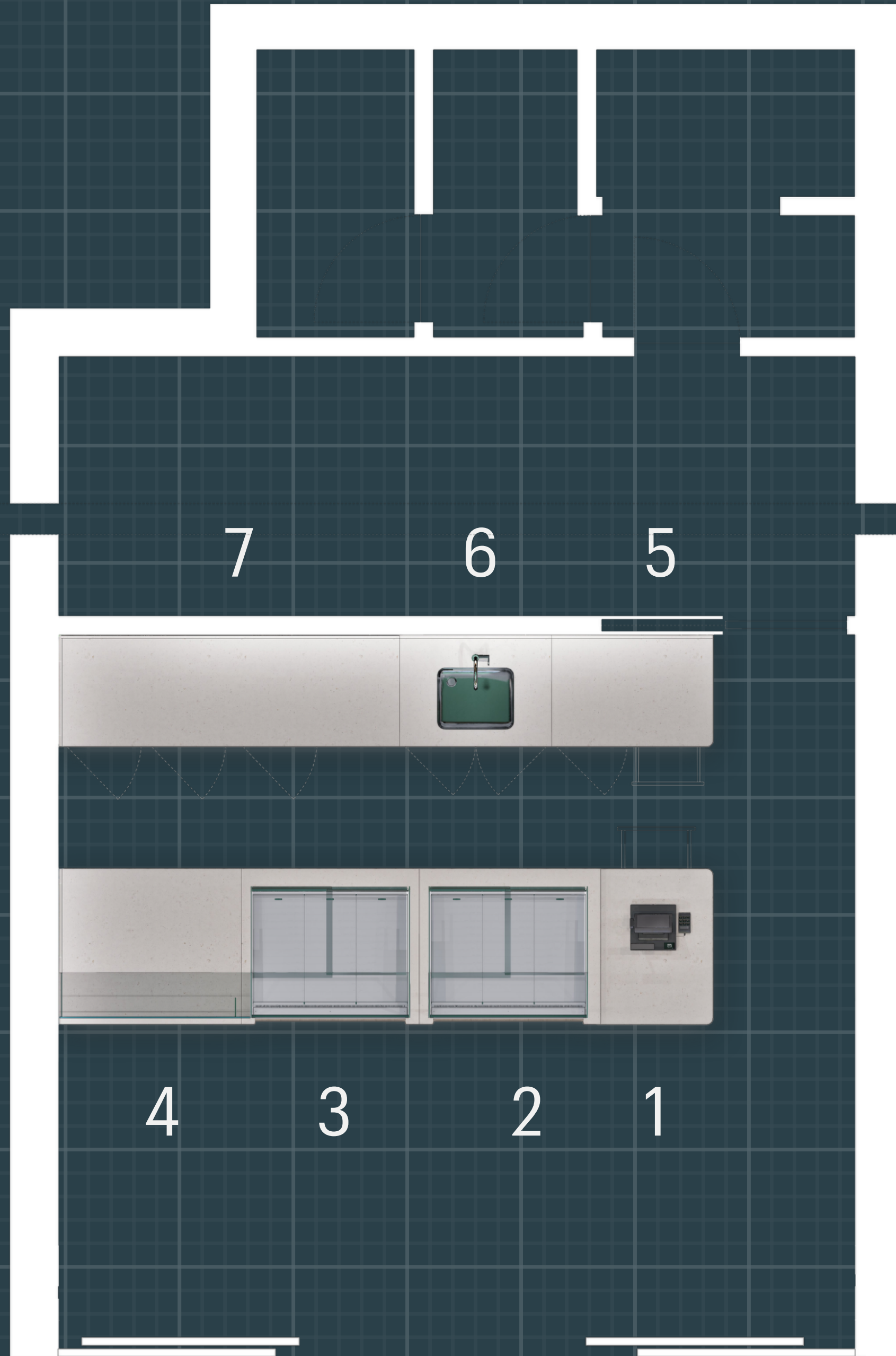

### **Furniture list - front counters:**

- 1-Checkout counter
- 2-Refrigerated Pastry Display case
- 3-Refrigerated Pastry Display case
- 4-Neutral counter with drawer

### **Furniture list - back counters:**

- 5-Back counter Coffee machine
- 6-Back counter sink
- 7-Back counter Three doors refrigerated

## 1 - CHECKOUT COUNTER



- Stainless steel frame
- 1 Stainless steel drawer
- 1 Stainless steel shelves
- Front panels made galvanized steel
- Plinth coated made galvanized steel

The checkout counter, with a **fully stainless steel frame**, is designed to ensure efficiency and organization in any operational setting. Equipped with **large stainless steel drawers and shelf**, it offers a durable, hygienic, and functional solution for space management. The Silestone® Cosentino surface guarantees long-lasting performance and easy cleaning, while the **front panels**, made of powder-coated galvanized steel with **high-resistance finishes**, complete the structure by combining strength with essential aesthetics.

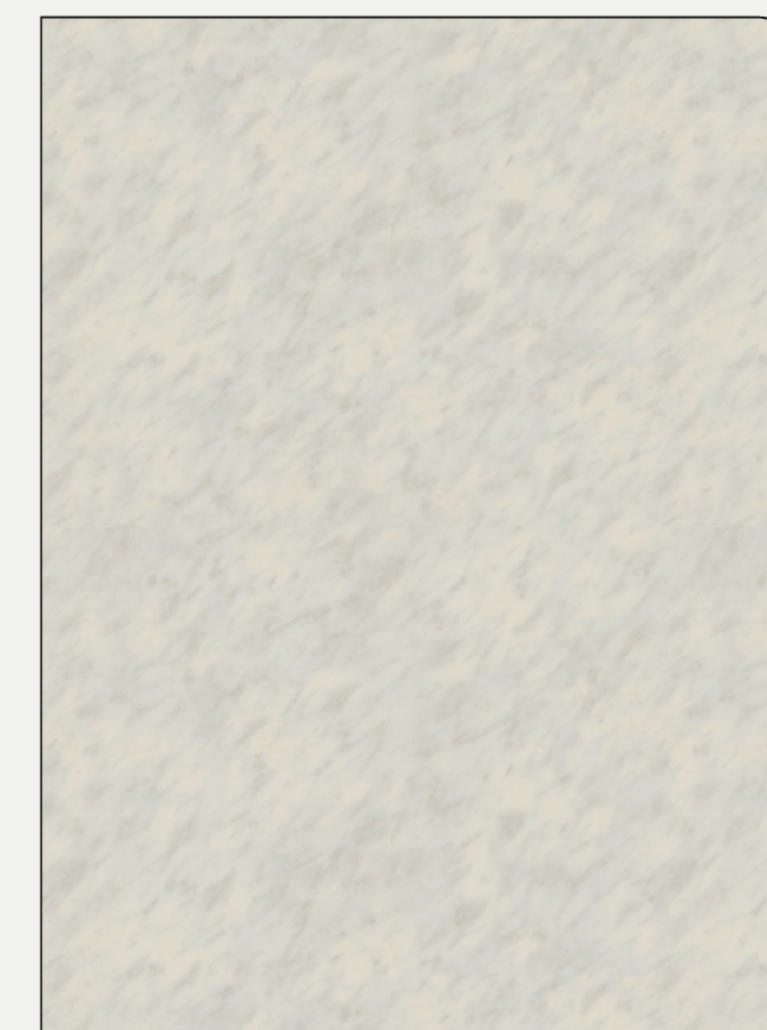

Checkout counter top in Silestone®

Dim: **W**x**L**x**H**  
inch: **40,1** x **29,1** x **33,8**  
cm: **102** x **74** x **86**

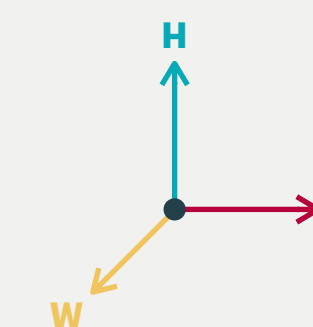

## 2/3 - REFRIGERATED PASTRY DISPLAY CASE

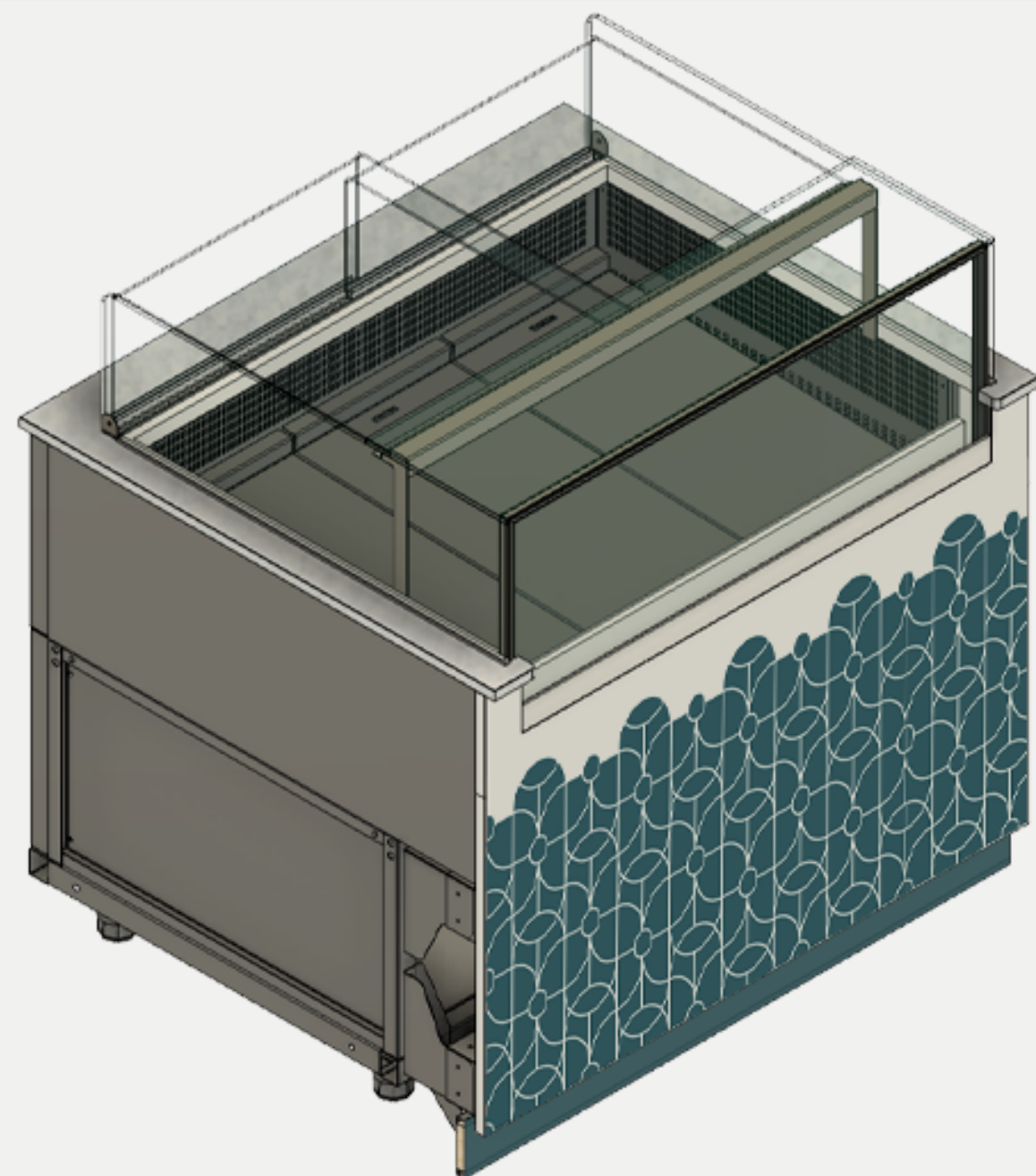

- Stainless steel frame
- 1 Stainless steel drawer
- heated double front glass
- Front panels made galvanized steel
- Plinth coated made galvanized steel
- compressor unit

**Pastry display case integrated into the furniture, entirely made of stainless steel.**

The heated double-glass front prevents fogging, ensuring maximum product visibility at all times. Designed with a strong focus on ergonomics, it offers customers an optimal view of the gelato while providing the operator with practicality and comfort in daily use.

It features a **professional control system** for precise temperature management and **integrated refrigeration units**. The **Silestone<sup>®</sup> Cosentino** surface guarantees durability and easy cleaning, while the front panels in **painted galvanized steel** with high-resistance finishes complete the structure, combining robustness with essential aesthetics.

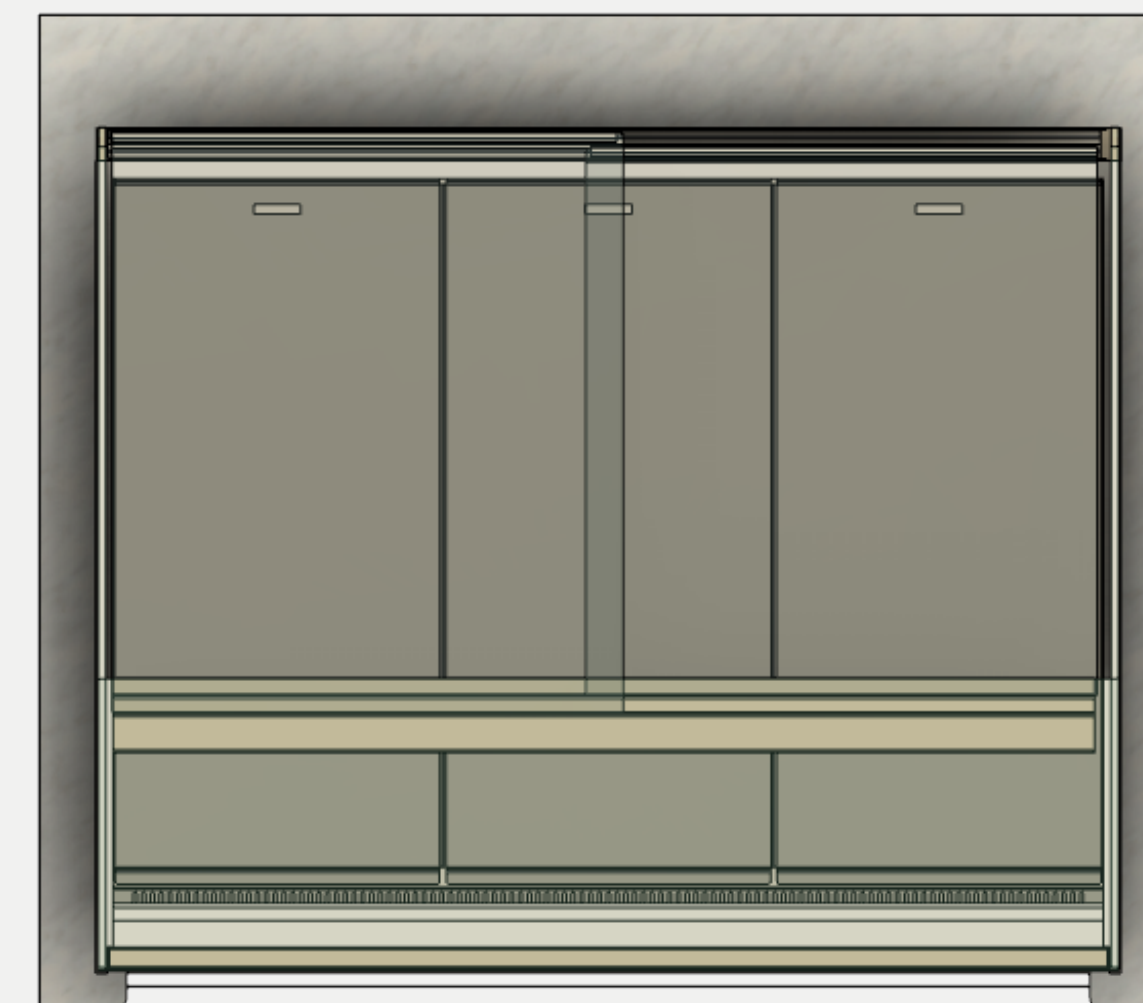

Pozzetti counter top in Silestone<sup>®</sup>

Dim: **W**x**L**x**H**

inch: **40,1** x **47,2** x **37**

cm: **102** x **120** x **94**

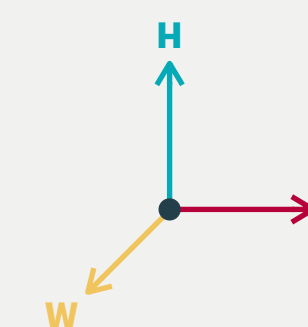



## 4 - NEUTRAL COUNTER

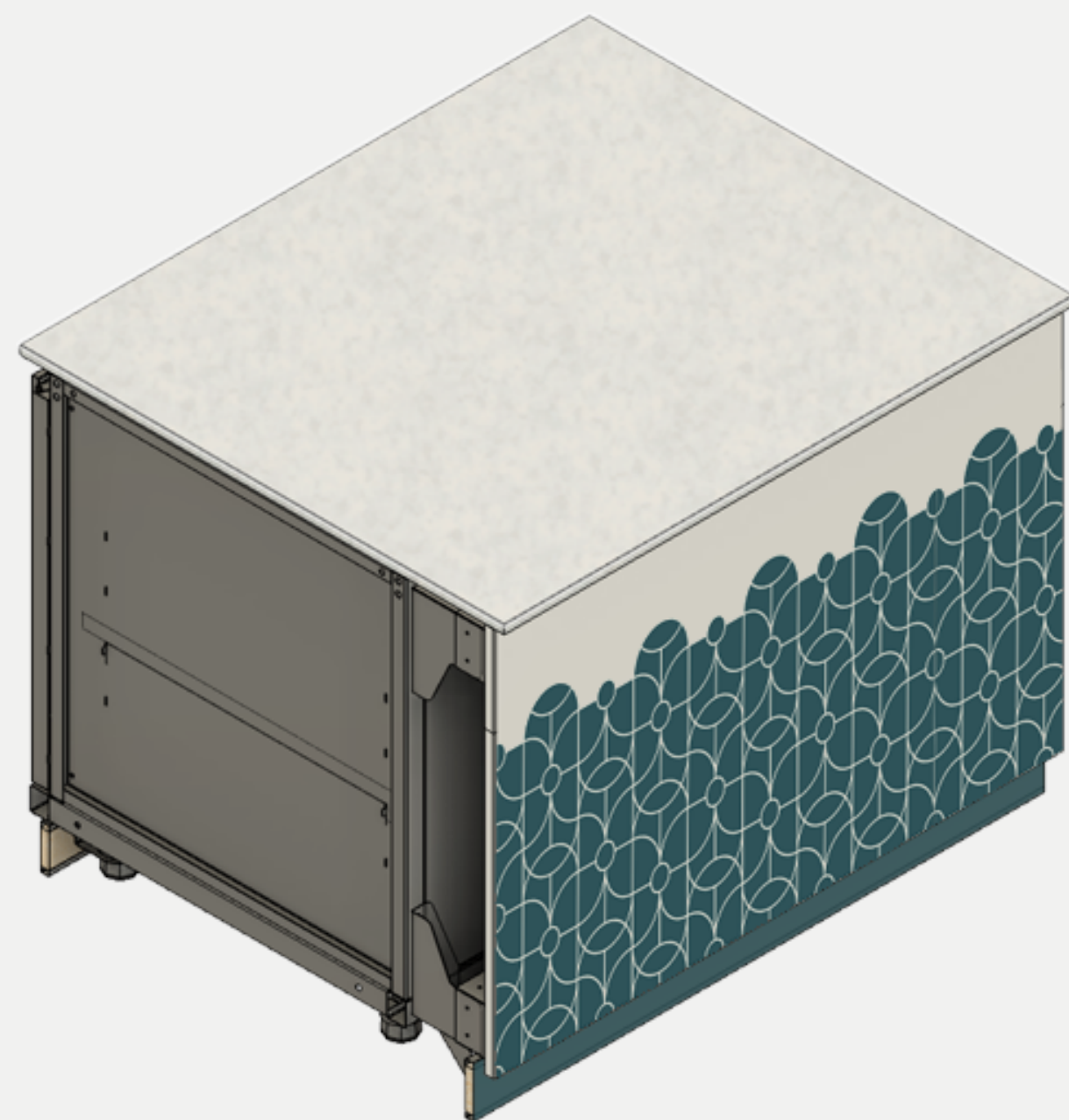

- Stainless steel frame
- 1 Stainless steel drawer
- 2 Stainless steel shelves
- Front panels made galvanized steel
- Plinth coated made galvanized steel

The neutral counter, with a **fully stainless steel frame**, is designed to ensure efficiency and organization in any operational setting. Equipped with **large stainless steel shelf, (or tailor made lay out)** it offers a durable, hygienic, and functional solution for space management. The Silestone® Cosentino surface guarantees long-lasting performance and easy cleaning, while the **front panels**, made of powder-coated galvanized steel with **high-resistance finishes**, complete the structure by combining strength with essential aesthetics.

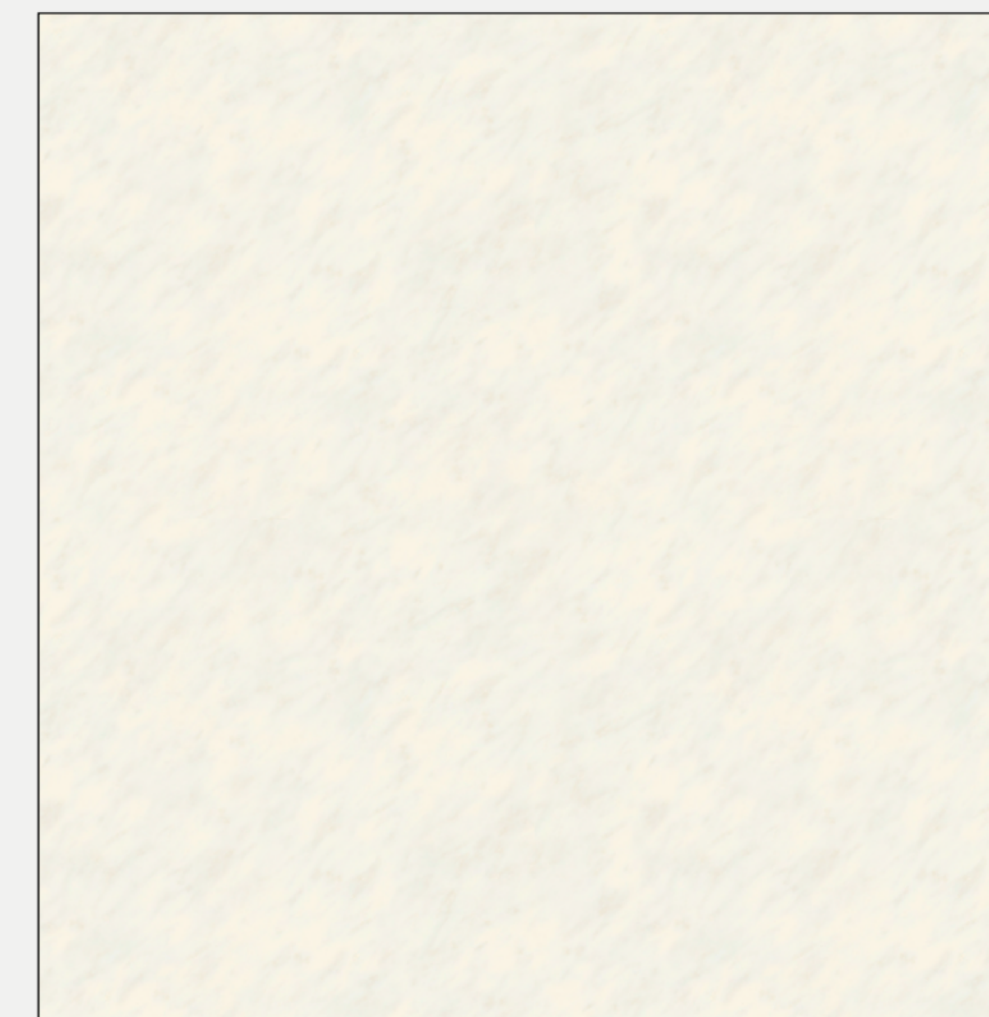

Pozzetti counter top in Silestone®

Dim: **W**x**L**x**H**

inch: **40,1** x **47,2** x **37**

cm: **102** x **120** x **94**

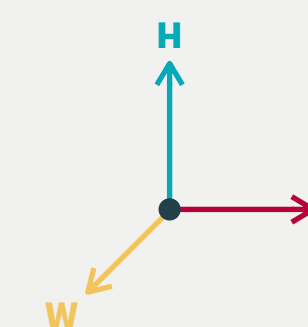

## 5 - BACK COUNTER COFFEE MACHINE

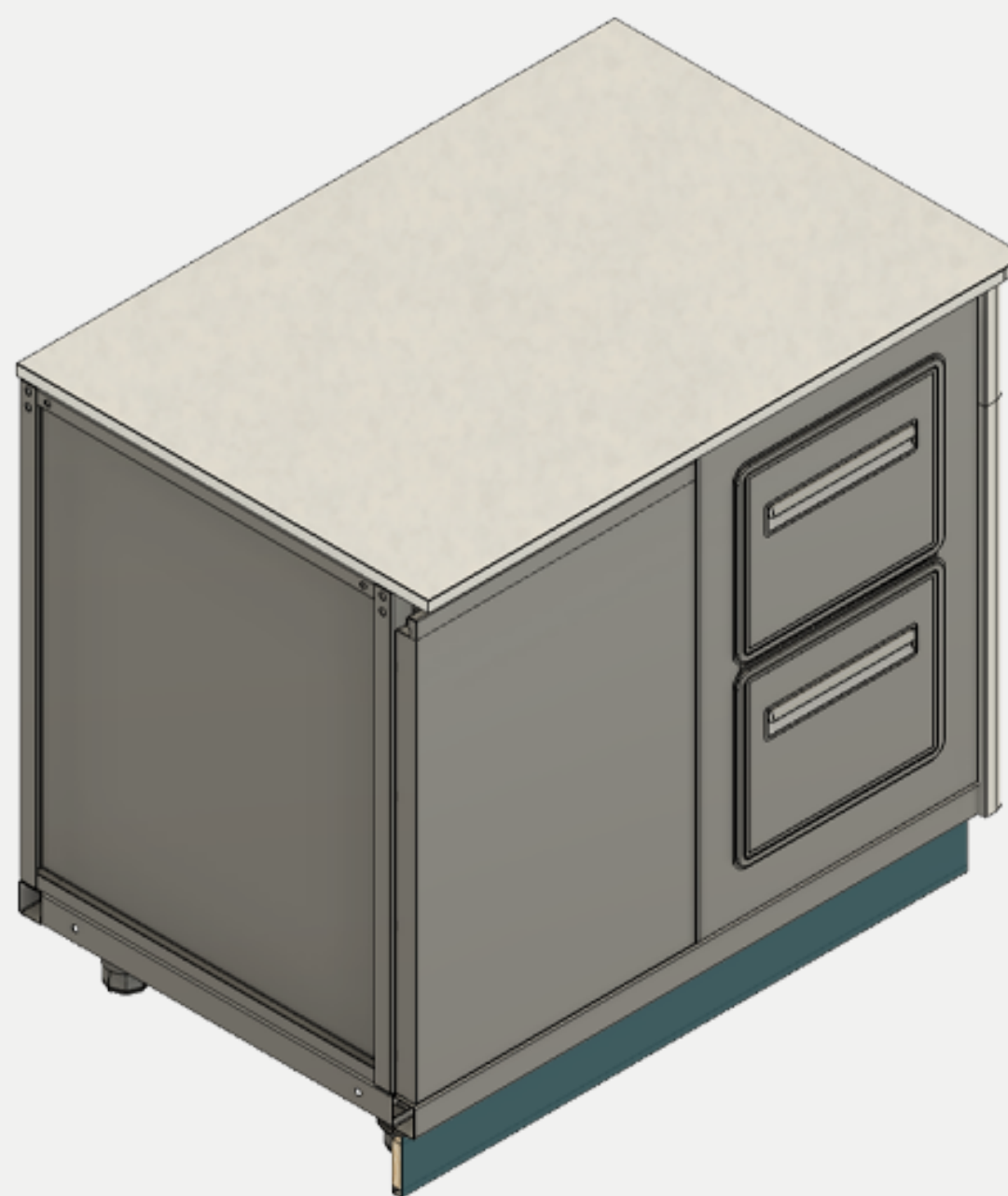

- Stainless steel frame
- 1 Stainless steel Cabinet doors
- 2 coffee drawer
- 2 Stainless steel shelves
- Plinth coated made galvanized steel

The coffee machine back counter, made entirely of stainless steel with a stainless steel door, is designed to ensure durability, hygiene, and everyday practicality. Equipped with **two hoppers for coffee preparation**, it offers an efficient and functional solution for industry professionals. The **Silestone® Cosentino** surfaces ensure long-lasting performance, easy cleaning, and a refined look—ideal even for areas visible to customers.

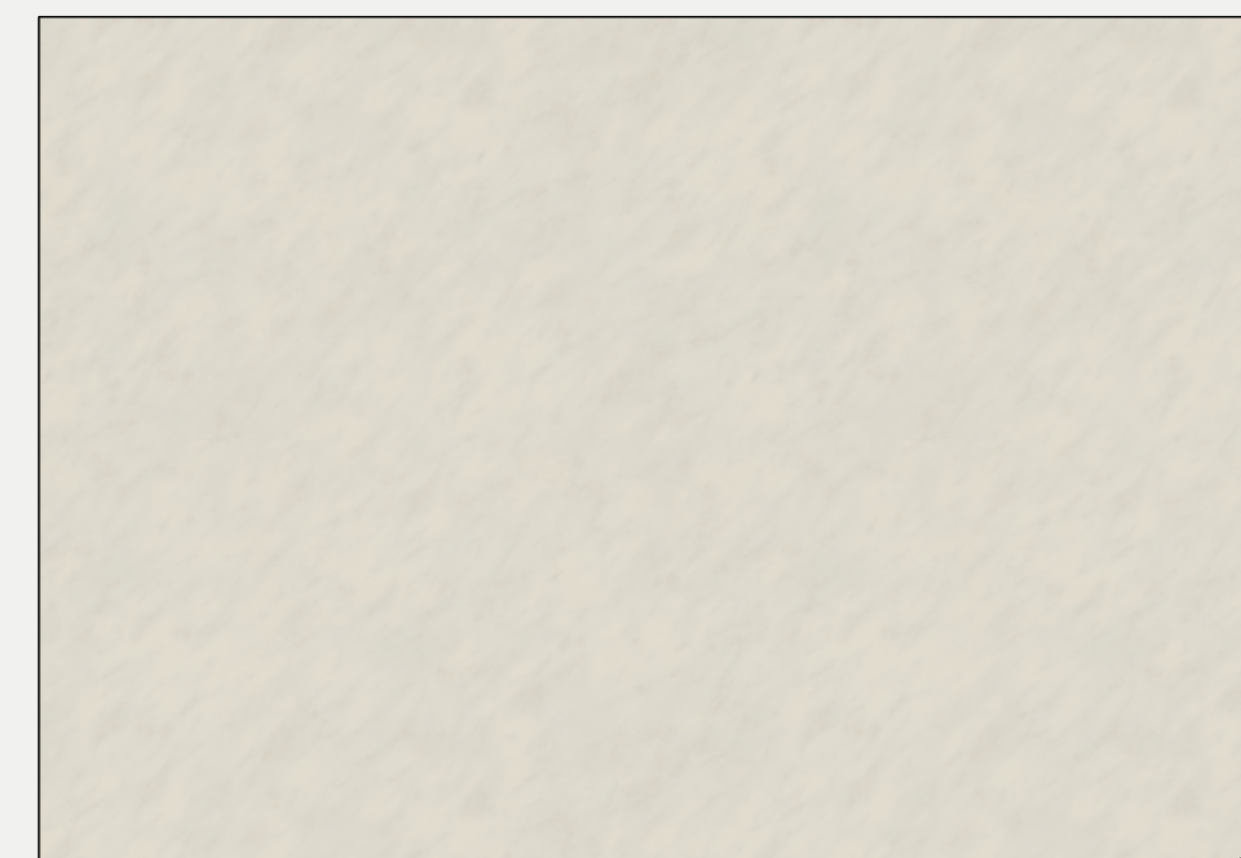

Pozzetti counter top in Silestone®

Dim: **W**x**L**x**H**

inch: **28,7** x **41,7** x **37**

cm: **73** x **106** x **94**

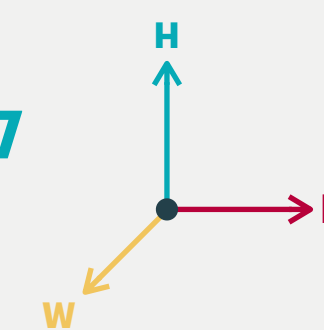



## 6 - BACK COUNTER SINK

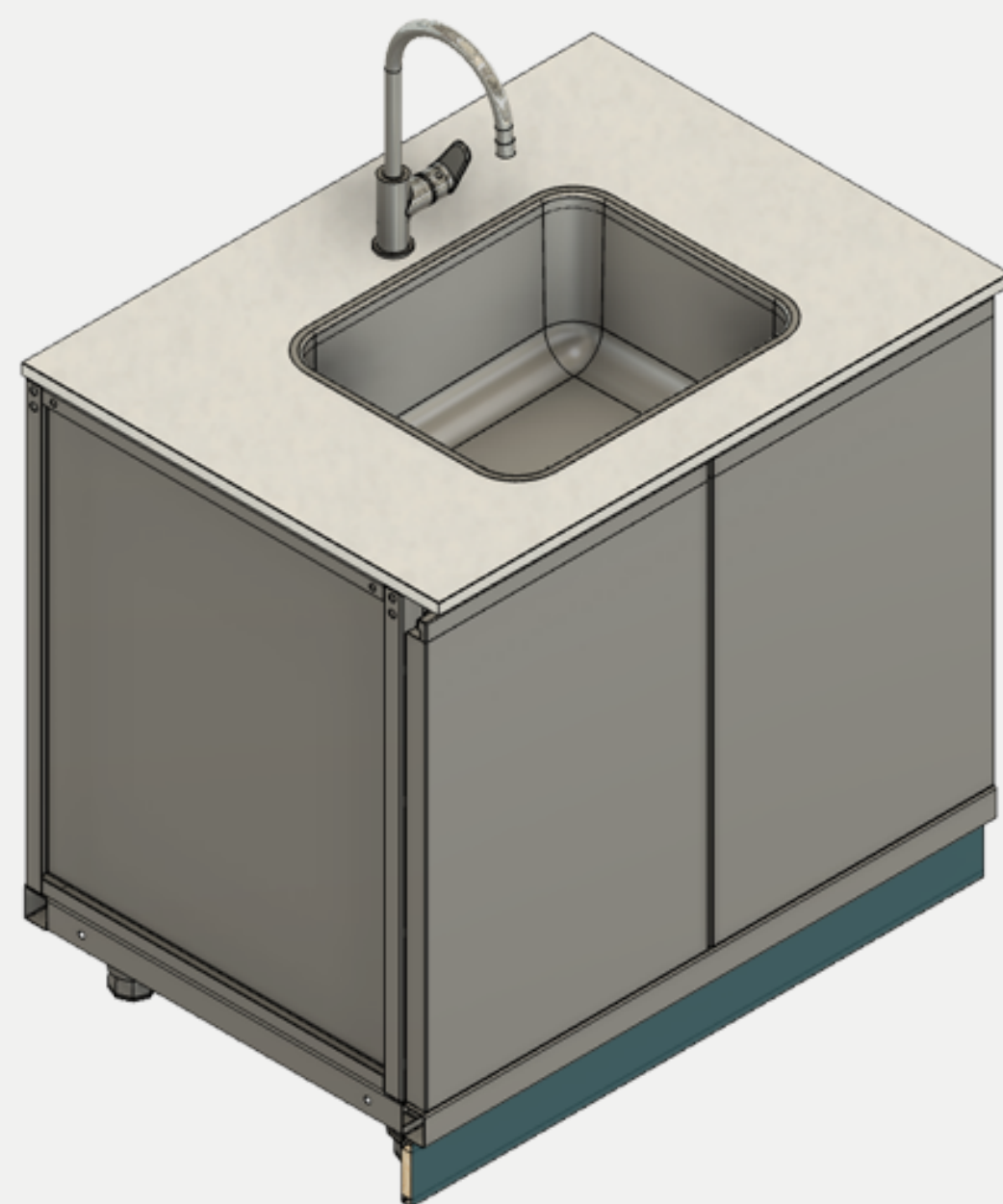

- Stainless steel frame
- 2 Stainless steel Cabinet doors
- Stainless steel sink and tap
- 2 Stainless steel doors
- Plinth coated made galvanized steel

The professional **sink unit**, with a **fully stainless steel frame and doors**, is designed to ensure durability and functionality in demanding work environments. Equipped with a **large sink** and **professional faucet**, it combines practicality and ease of use while remaining **elegant and visually appealing to the public**. The Silestone® Cosentino surface guarantees durability and easy cleaning

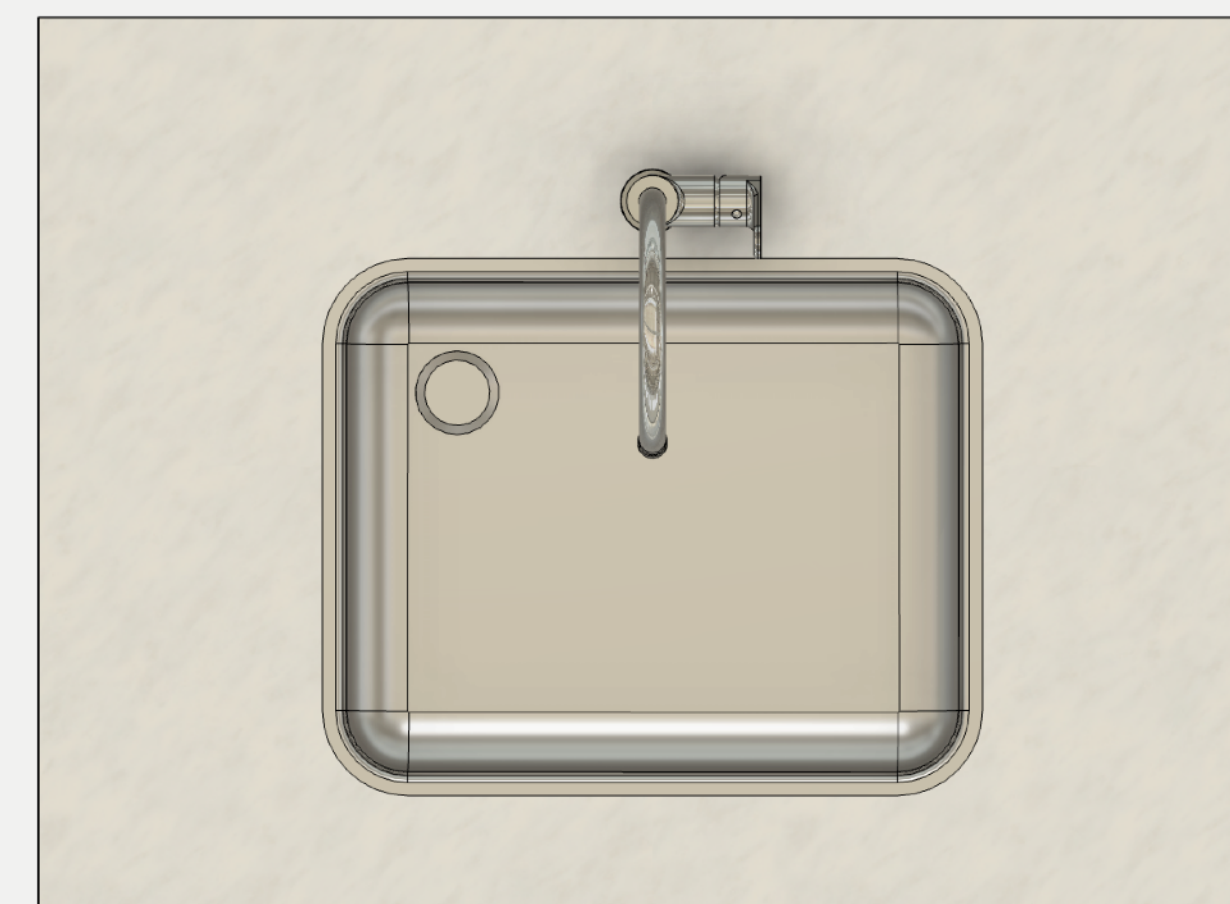



Pozzetti counter top in Silestone®

Dim: **W**x**L**x**H**

inch: **28,7** x **39,3** x **37**

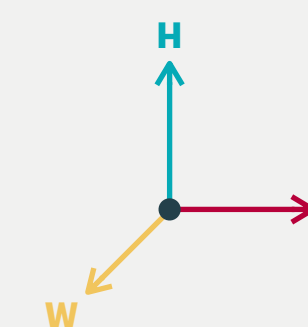
cm: **73** x **100** x **94**



 **7 - BACK COUNTER 3 DOORS REFRIGERATED**

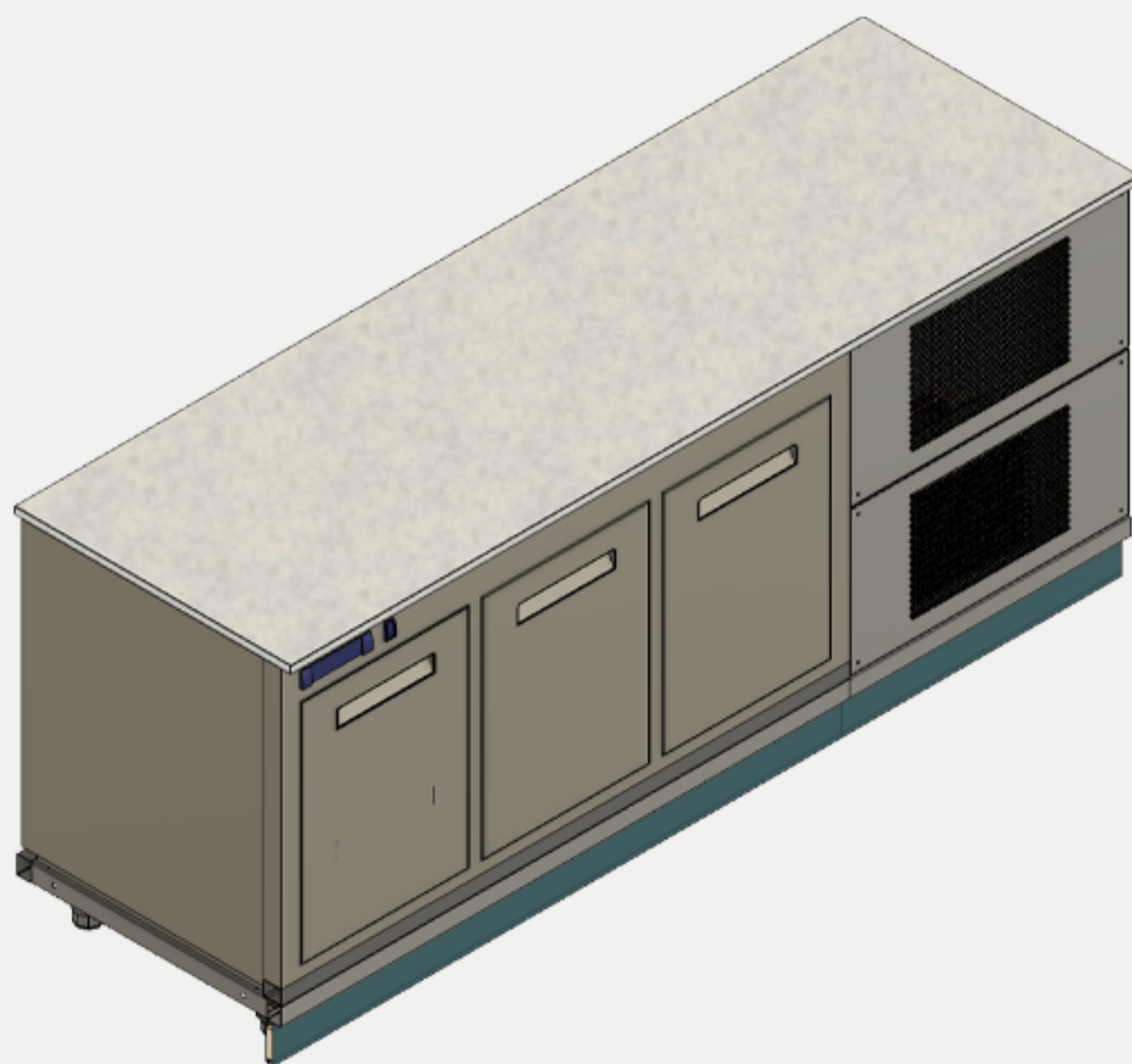

- Stainless steel frame
- 3 Doors refrigerated cabinet
- compressor unit
- Plinth coated made galvanized steel

The refrigerated cell, with a fully stainless steel structure, is designed to ensure maximum hygiene, durability, and reliability. Equipped with an **on-board refrigeration unit**, it provides precise temperature control in all operating conditions. The **Silestone® Cosentino** surface completes the system, offering high durability and easy cleaning.

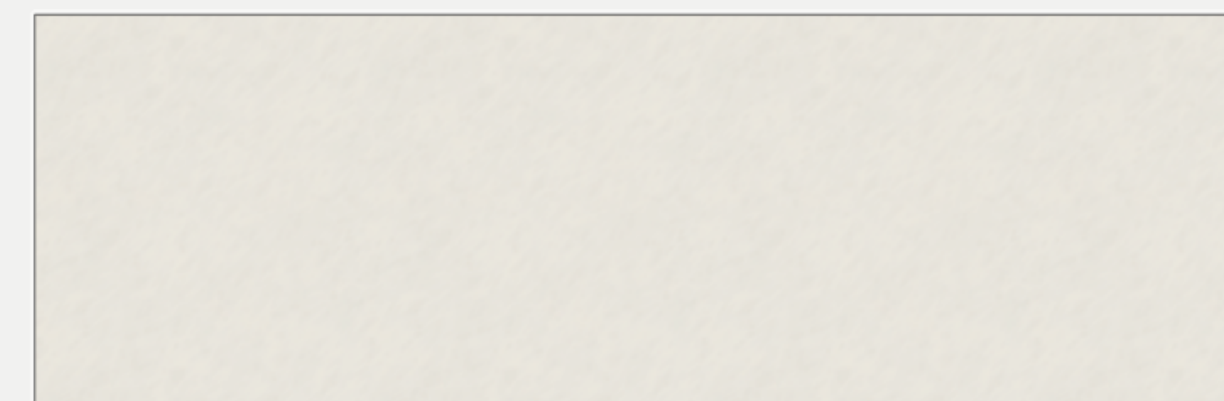

Pozzetti counter top in Silestone®

Dim: **W**x**L**x**H**

inch: **28,7** x **88,1** x **37**

cm: **73** x **224** x **94**

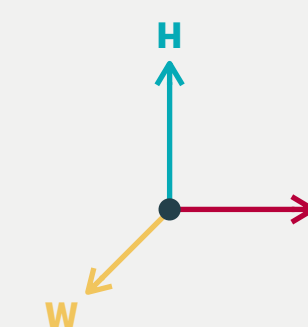

## **FOOD GLASS PROTECTION**

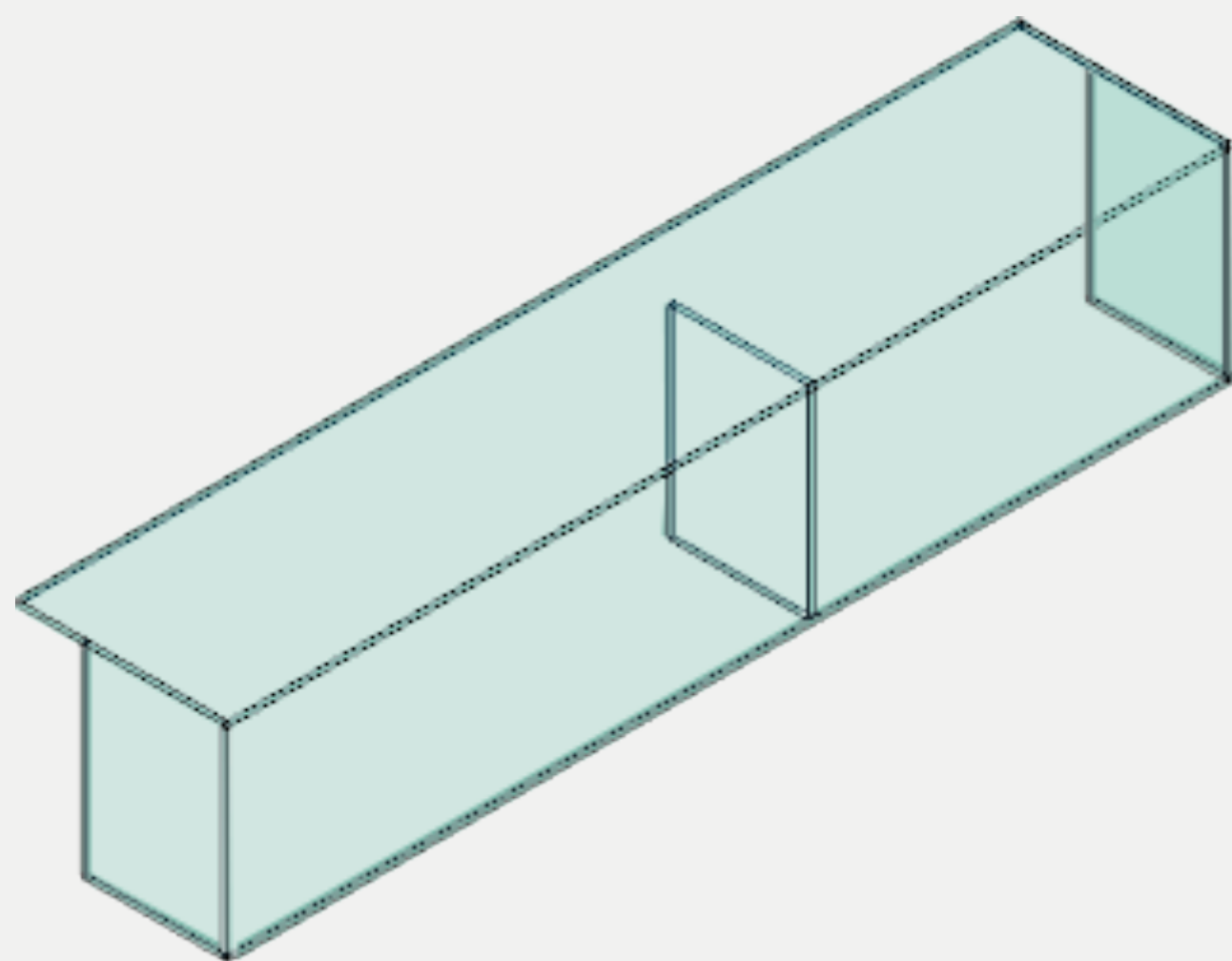

-n 1 food glass protection

The **food glass protection** is custom-made with **1 cm thick tempered glass**, ensuring maximum strength, safety, and transparency. Ideal for protecting food in professional settings, it combines functionality and elegance, perfectly adapting to any display counter.

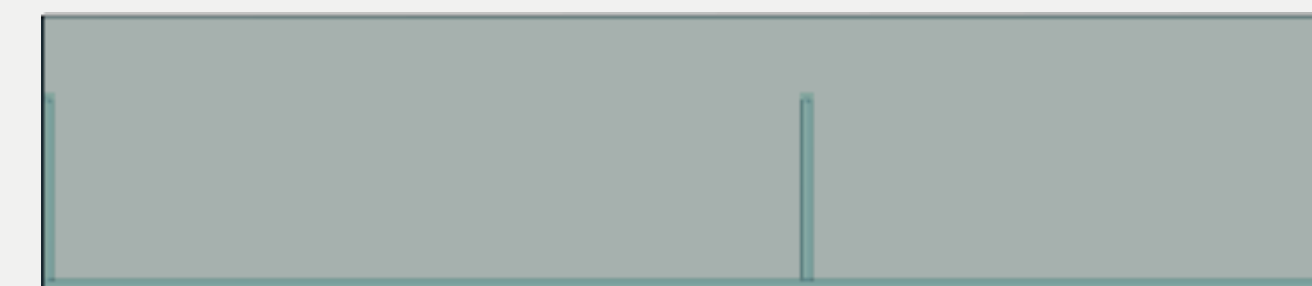

Tempered glass

Dim: **W**x**L**x**H**

inch: **9,8** x **47,2** x **9,8**

cm: **25** x **120** x **25**

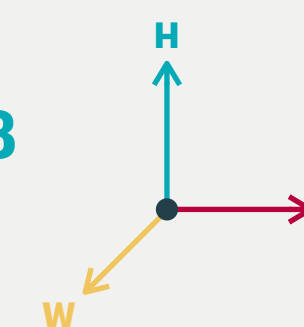



## SPLASH GUARD

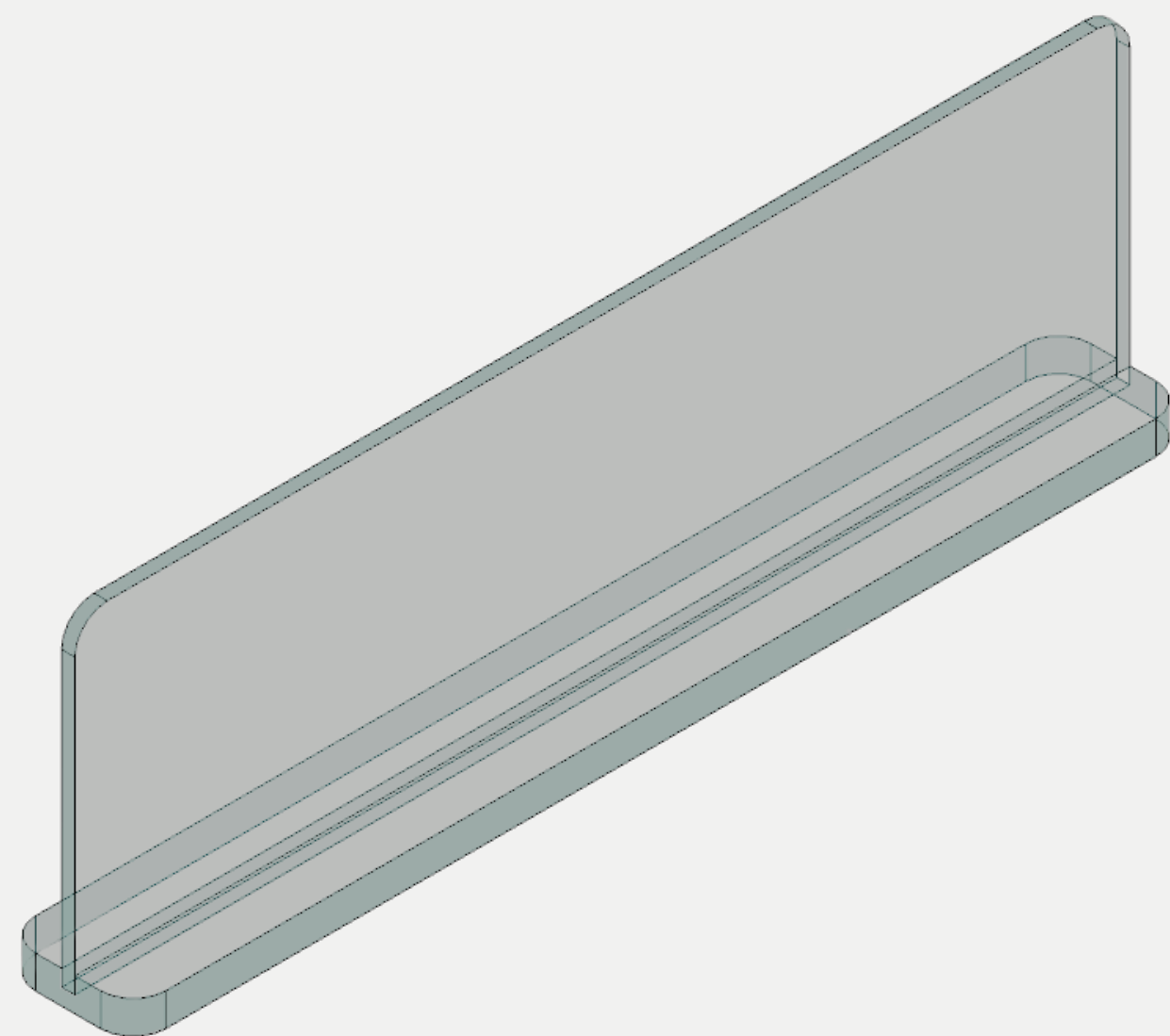

-N2 Splash Guard

### Transparent polycarbonate splash guard

Provides safe protection while keeping the work area clean, without compromising the aesthetic of the space thanks to its transparency and discreet design.

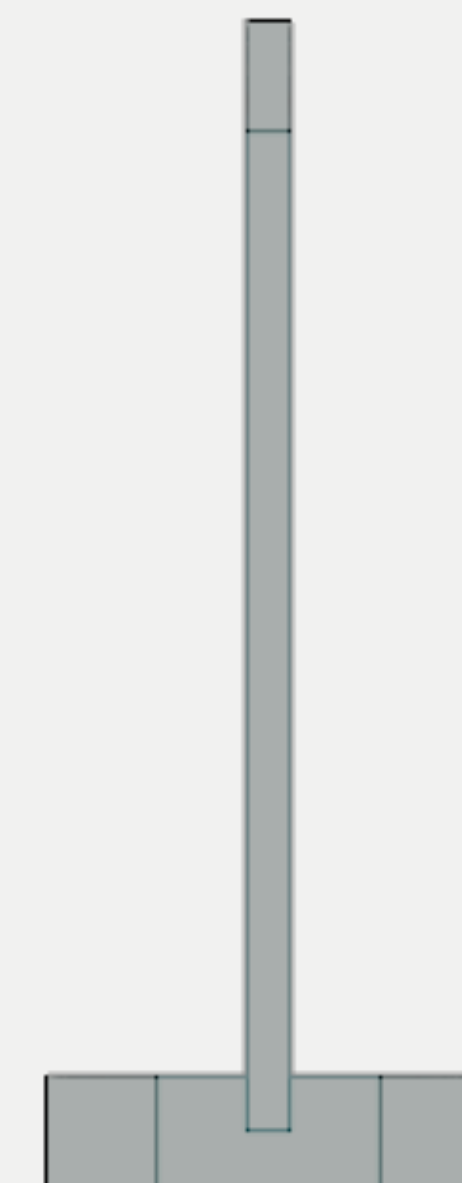

Polycarbonate

Dim: **W**x**L**x**H**

inch: **27,5** x **4,7** x **8,7**

cm: **70** x **12** x **22**

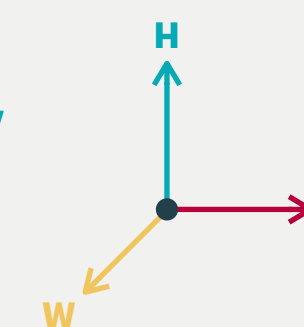



## I RIVESTIMENTI: I PIANI

# silestone®

By COSENTINO®

A leading brand for over 30 years that inspires designs for kitchens, bathrooms and commerciale surfaces.

**25 Years warranty**  
Hybrid mineral surfaces to create innovative spaces that endure over the time.

### Advantages and properties



**Elevata resistenza ai graffi**  
l'uso e l'usura quotidiana non graffiano Silestone.

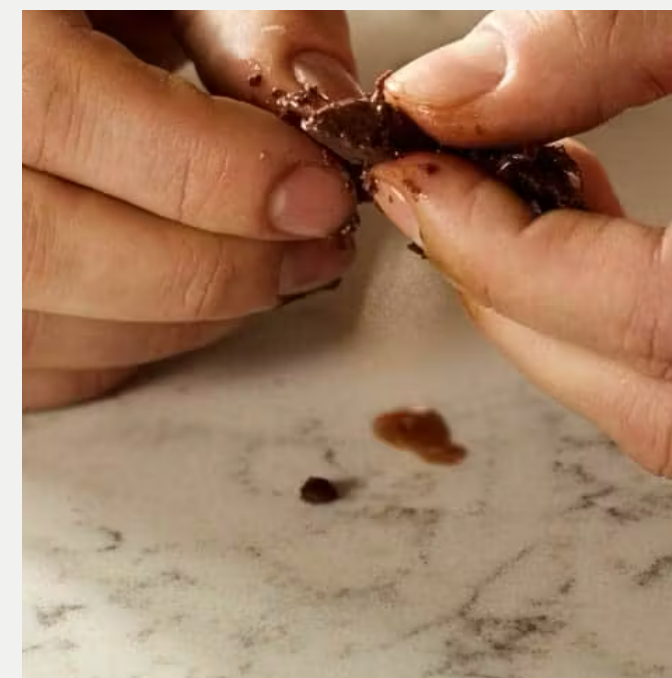

**Elevata resistenza alle macchie**  
La bassa porosità li rende altamente resistenti alle macchie.



**Alta resistenza agli urti**  
Altamente resistente agli impatti quotidiani.

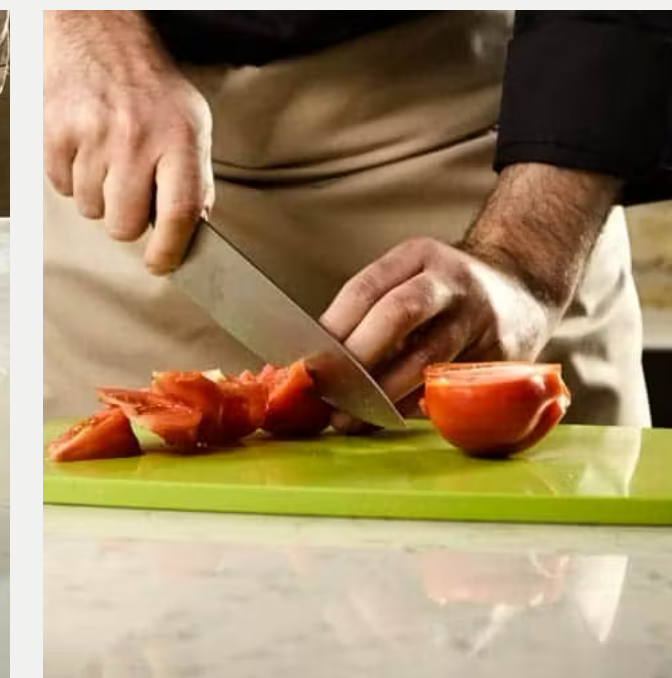

**Elevata resistenza agli acidi**  
La bassa porosità gli impedisce di essere danneggiato da macchie aggressive.

### Finish



**Polished**  
More vibrant and intense colors and reflections

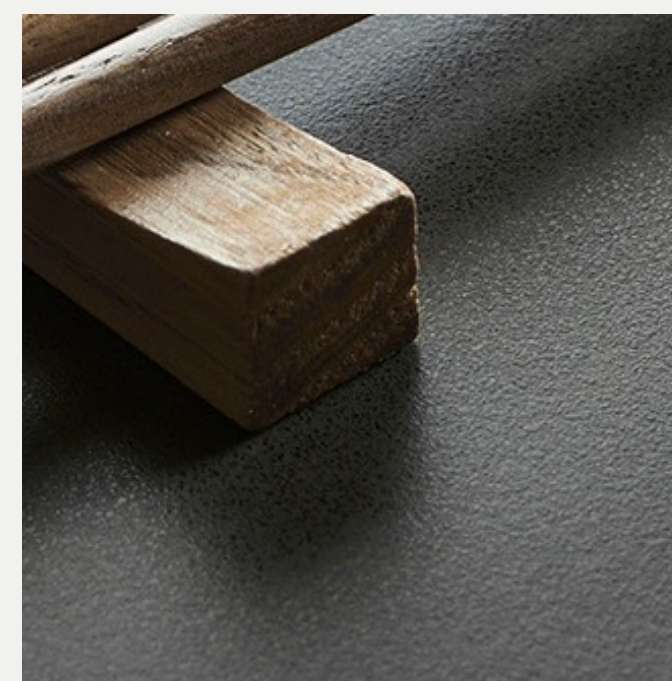

**Suede**  
Soft and pleasant feel with full color consistency

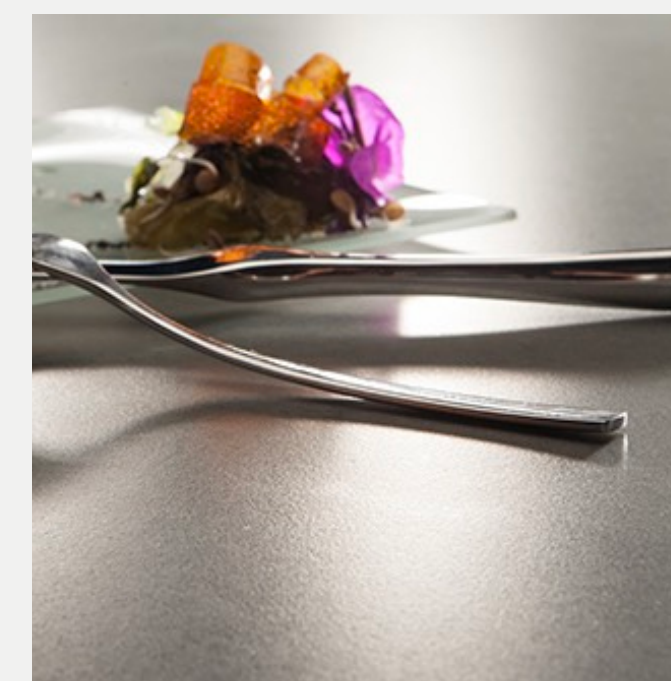

**Mate**  
Solid and satin color

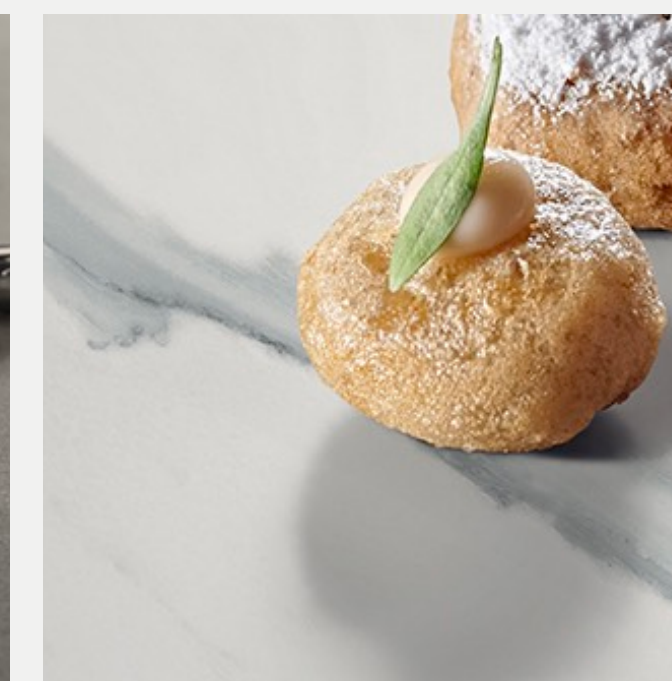

**Velvet**

**Maintenance**



Click the colors to see them in use

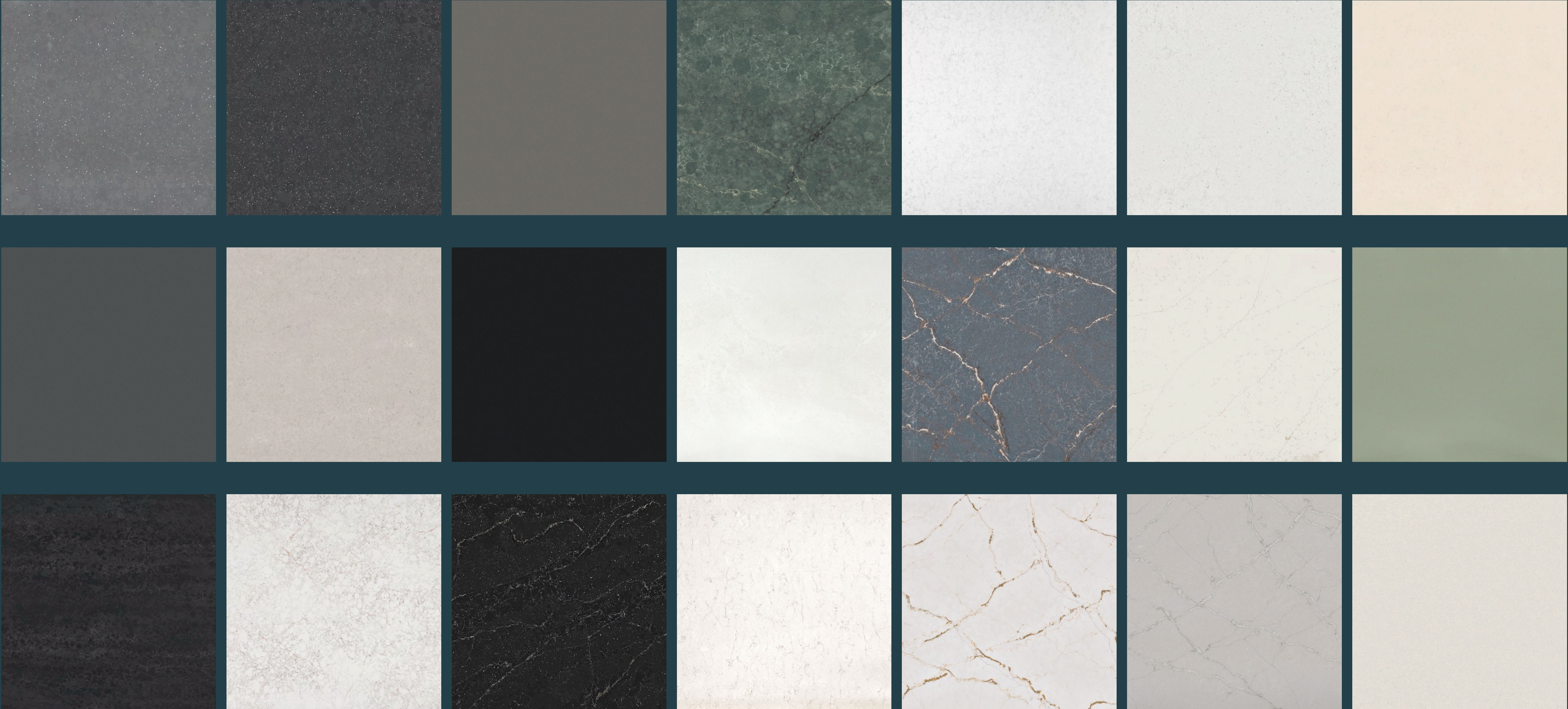

 **COLORS WITHOUT LIMITS**



[RAL Chart](#)

**PANTONE®**

[Pantone Chart](#)

**kerakoll**

[Kerakoll Chart](#)

With TekneItalia, you're never confined to a preset color palette. **We offer access to thousands of colors** through internationally recognized systems like **RAL** and **PANTONE\***, ensuring your customization is truly **limitless**. Whatever shade you envision, we can bring it to life—without compromises and without boundaries.

 **COLORS WITHOUT LIMITS**

# 3M

# DI-NOC™

**3M™ DI-NOC™ Architectural** E-Series PO Polyolefin Film are film surface finishes that give you a range of choices as you pursue your sustainability goals. These films are made with approximately 99.5% non-PVC (non-vinyl) materials, and do not contain more than 0.5% of a polyvinyl chloride-based component. **These finishes are available in various patterns and textures – wood, plaster, concrete and more, and are a great way to upgrade your interior look without all the disruption.** 3M™ Comply™ Adhesive technology virtually eliminates air bubbles, simplifying and speeding up the application process.



**Catalogue 3M Di - NOC**



## TOTAL CUSTOMIZATION

With TekneItalia, every piece of furniture becomes a **unique expression of your brand**. **Integrated “under-surface” digital graphics, stencil techniques, and glossy or matte finishes are just some of the available options.** Thousands of combinations of materials, colors, and details allow you to create truly tailor-made solutions, with no limits to customization.





## PROMINENT DETAILS

**Laser-engraved details add depth and personality to the furniture**, with the option to be painted or finished with an elegant 24-carat gold plating. **Custom-made**, these exclusive elements transform any space, making your venue unique and **instantly recognizable**.



THIS IS A **TEKNEITALIA**® PROJECT

**Tekneitalia** is a company founded **over 15 years ago** with the clear and ambitious goal of revolutionizing the way business is done in the HO.RE.CA. sector. Through **carts and mobile devices with iconic and highly recognizable design**, we have made **beauty a tool for work**. From day one, our mission has been to offer clients **not only functional tools but true extensions of their identity**: objects capable of expressing **values, emotions**, and visions through a refined and **timeless aesthetic**.

**TEKNEITALIA**®  
Brows our website



**TEKNEITALIA**®



**YOUR PROJECT, GUIDED BY EXPERT**

A dedicated team of **architects and graphic designers** will support you at every stage of development, working closely with you to create the best version of your project. Thanks to 3D modeling in a virtual environment, you'll be able to explore every detail of your venue before implementation, choosing each element with precision and ensuring a flawless result.

Contact us and **share your needs** to discover how we can **turn your project into reality**. Receive detailed information and a personalized quote, with **no obligation**.

**[INFO@TEKNEITALIA.COM](mailto:INFO@TEKNEITALIA.COM)**

**MOBILE OFFICE: +39 328 221 34 74**

**MOBILE SALES EXPORT: + 39 366 421 23 63**

**TEKNEITALIA USA: +1 212 810 6725**