

 SHOP SIZE- 30 SQM/323 SQF

# ICE CREAM SHOP





## DESIGN HIGHLIGHT

The project stems from the desire of a historic family of gelato makers to renew themselves **without losing their identity**. The gelateria becomes a **neighborhood landmark**: a welcoming, contemporary space that blends **tradition** and **innovation**.

Authentic materials such as **wood** and **stone** interact with **clean lines** and colors inspired by the **natural tones of gelato**, enriched with vibrant accents. Large windows open the space to the street, transforming it into a neighborhood **"piazza,"** a place for **connection and conviviality**.

A restyling that is not merely aesthetic, but a **manifesto of identity**: strong roots, with an eye toward the future.



























## VIRTUAL TOUR

Discover our virtual environments: **explore in 3D the spaces designed for you**, experience immersive engagement, and make confident decisions. **Find the right inspiration** to create a tailor-made, innovative, and unique venue.



Virtual Tour



## MOODBOARD

The gelateria's design blends **sophistication** and **functionality**. **Neutral tones** and **glossy surfaces** create a bright, inviting atmosphere, while **golden details** and **geometric lines** evoke a **classic elegance** reinterpreted in a contemporary key. Suspended globe lights add a refined touch, harmonizing with the **wood** and **stone** counter that serves as the visual centerpiece of the space. A welcoming yet distinctive environment, designed to transform a simple gelato break into a **stylish experience**.





## FLOOR PLAN

The project aims to keep the gelateria as a **true community hub**, a real point of reference **for the neighborhood**. The **interior layout** prioritizes **simplicity and functionality**, with a large central counter that facilitates service and encourages guests to stay. **Seating along the walls** optimizes space, ensuring **smooth circulation**.

The key element is the **connection to the exterior**: **large windows** create continuity between the interior and the street, flooding the space with natural light and inviting passersby inside. Outside, a **furnished area** with tables and chairs becomes a small **“urban piazza”**, a **natural extension** of the venue designed for **convivial moments** in the open air and to strengthen ties with **neighborhood life**.

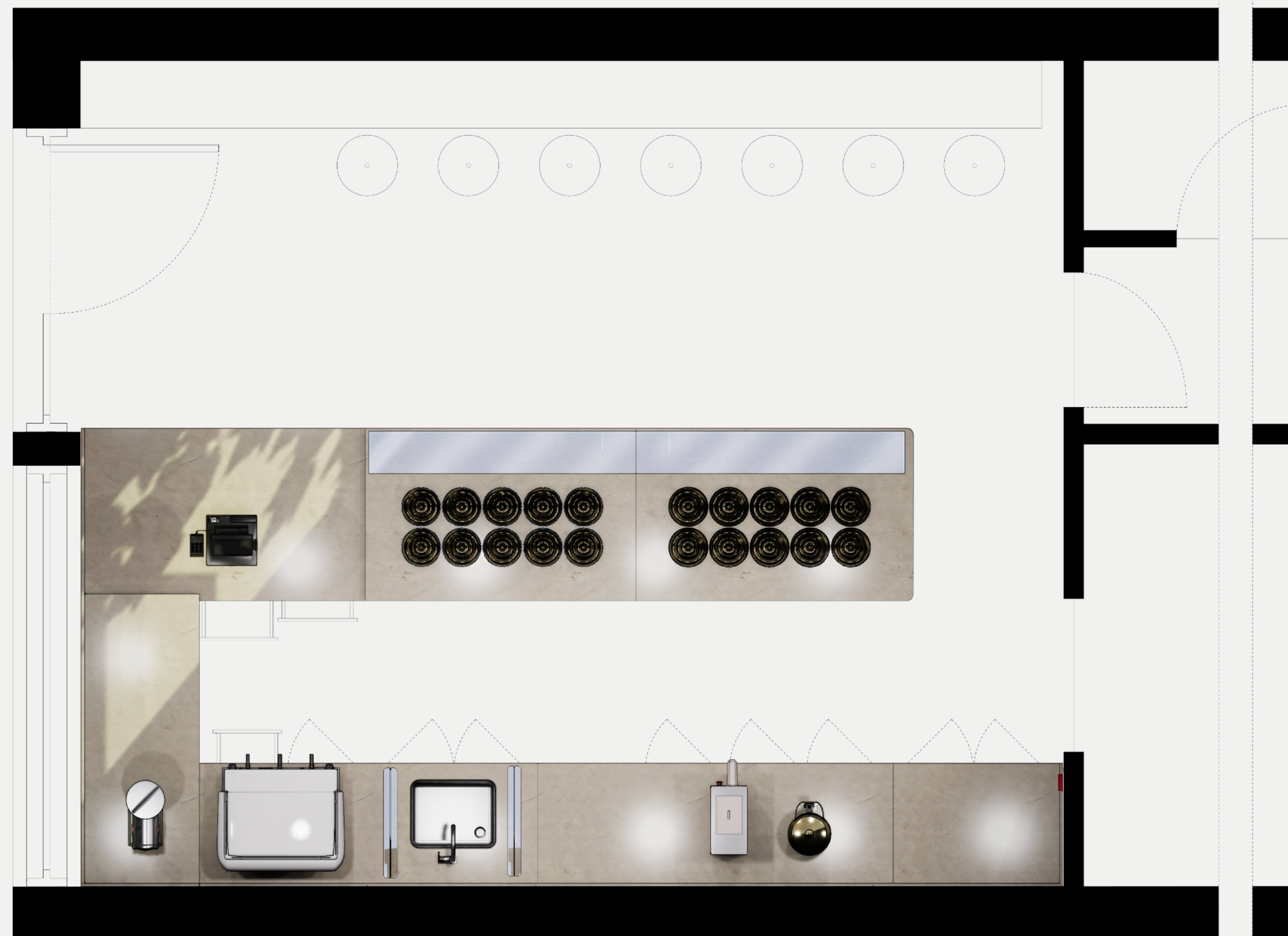



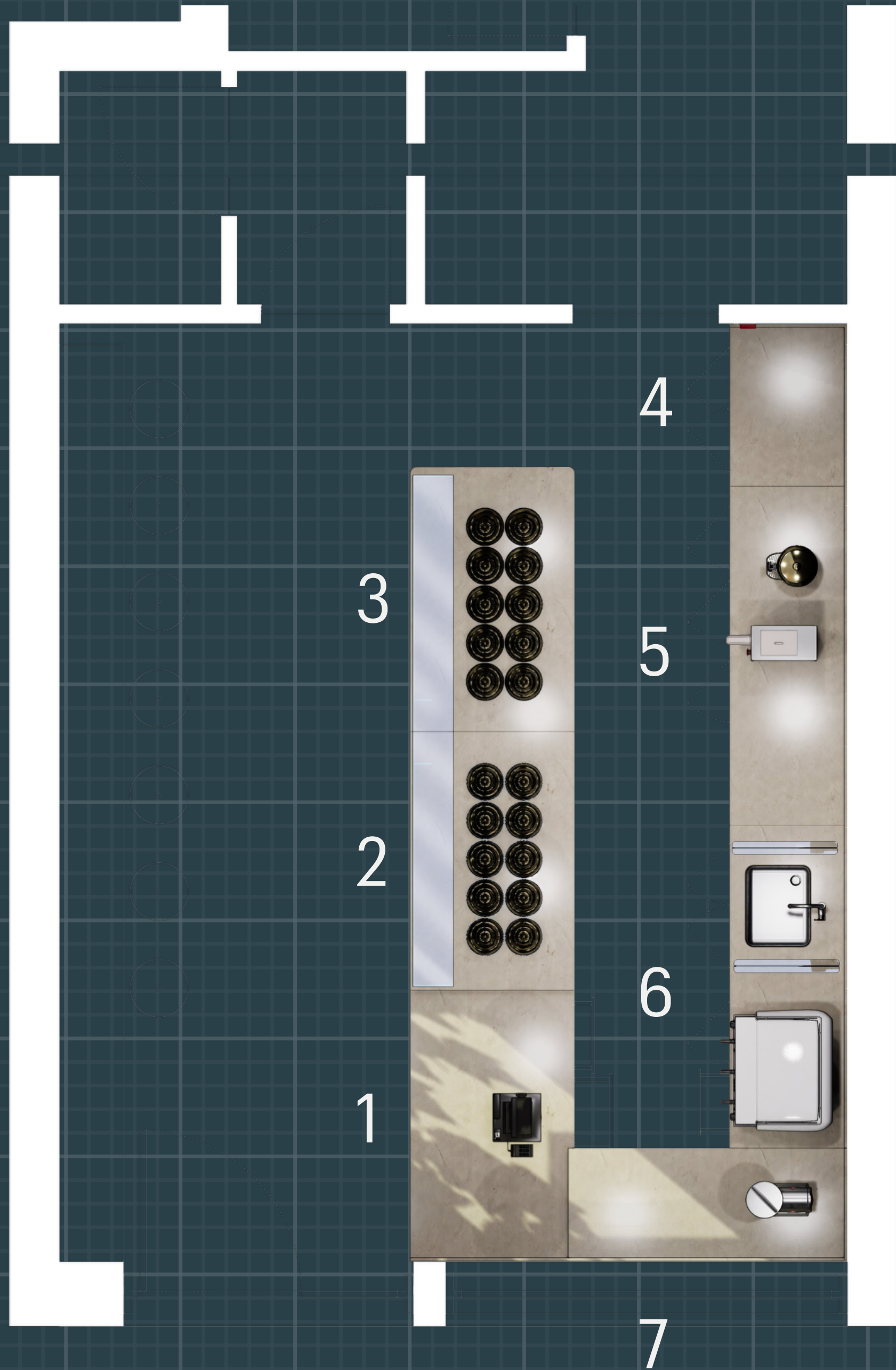

## FURNITURE LIST

### Furniture list - front counters:

- 1-Checkout counter
- 2-Pozzetti Counter 10 flavors
- 3-Pozzetti Counter 10 flavors

### Furniture list - back counters:

- 4-Neutral Back counter
- 5-Back counter Three doors refrigerated
- 6-Back counter Coffee machine and Sink
- 7-Neutral back counter corner



## 1 - CHECKOUT COUNTER

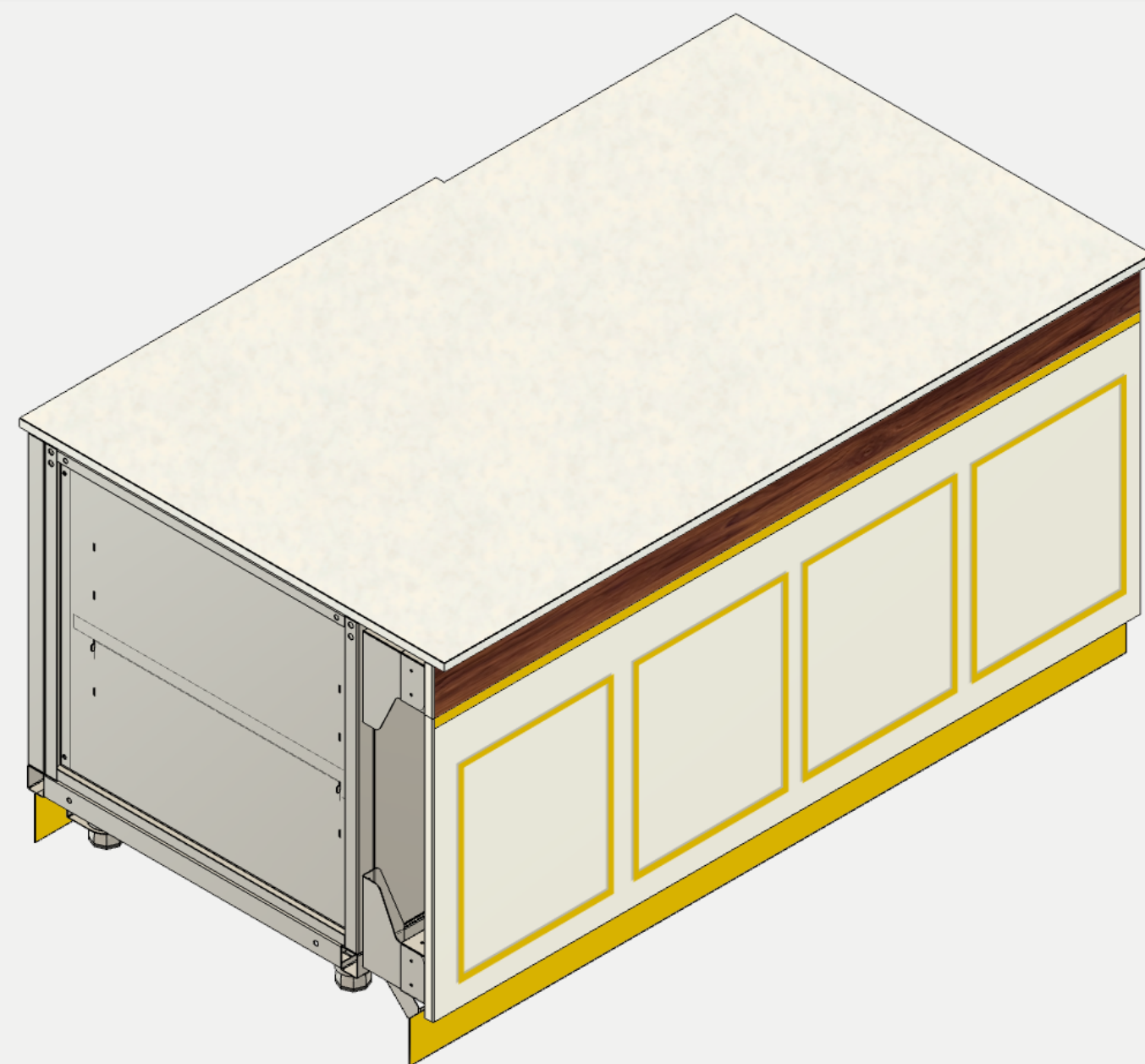

- Stainless steel frame
- 1 Stainless steel drawer
- 2 Stainless steel shelves
- Front panels made galvanized steel
- Plinth coated made galvanized steel
- Coated frames
- 3M Di-Noc Wood finishes

The checkout counter, with a **fully stainless steel frame**, is designed to ensure efficiency and organization in any operational setting. Equipped with **large stainless steel drawers and shelf**, it offers a durable, hygienic, and functional solution for space management. The Silestone® Cosentino surface guarantees long-lasting performance and easy cleaning, while the **front panels**, made of powder-coated galvanized steel with **high-resistance finishes**, complete the structure by combining strength with essential aesthetics.

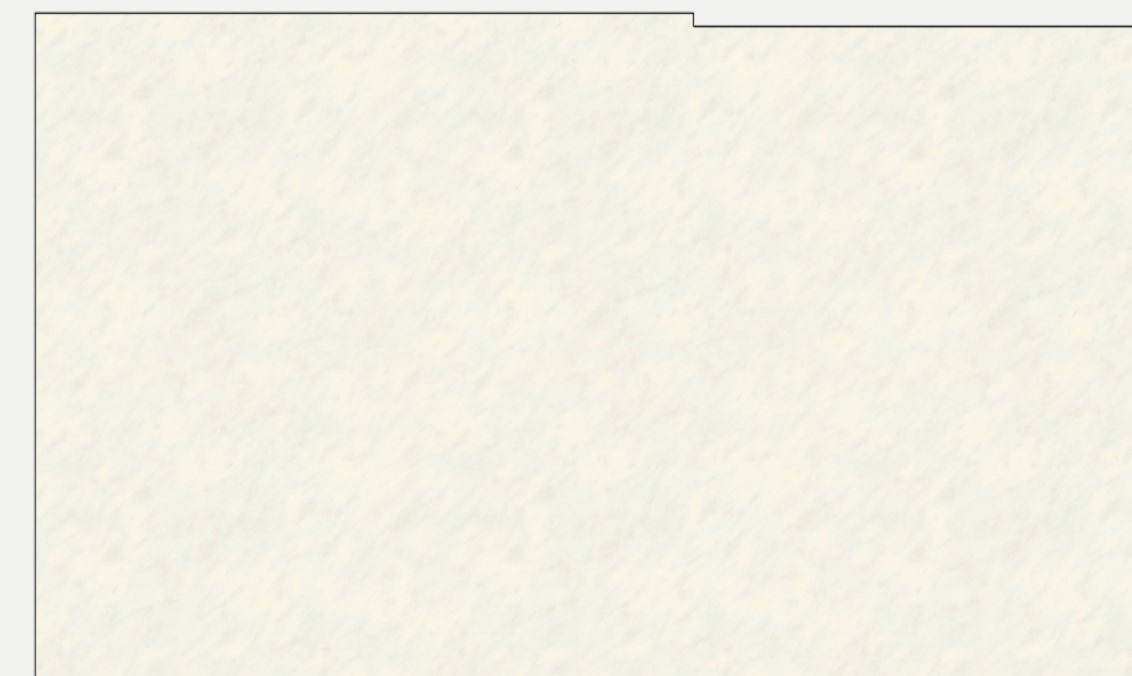

Checkout counter top in Silestone®

Dim: **W**x**L**x**H**

inch: **40,1** x **66,1** x **33,8**

cm: **102** x **168** x **86**

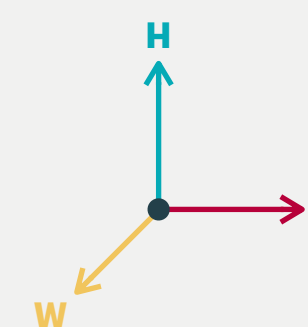



## 2 - POZZETTI COUNTERS

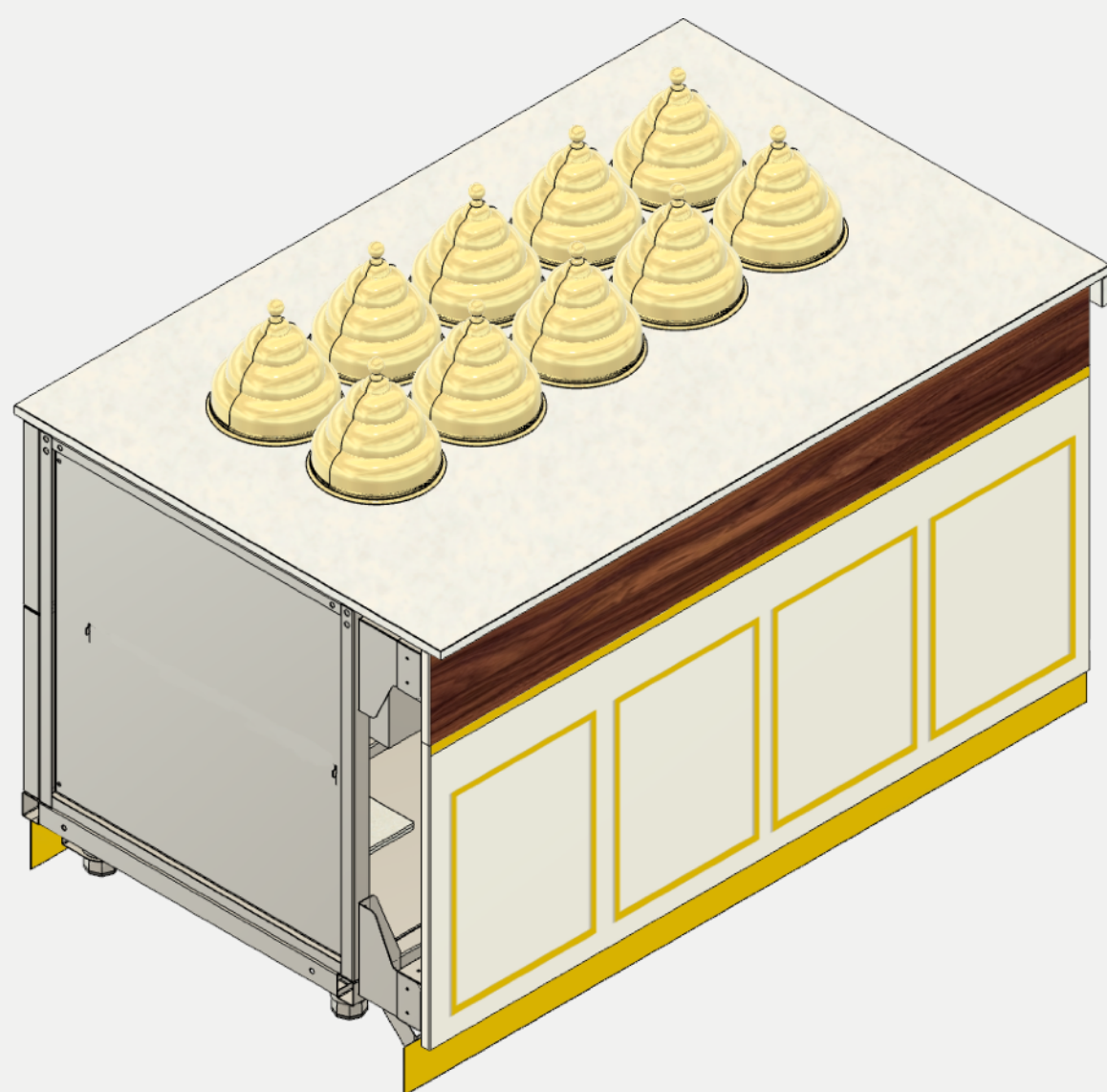

- Stainless steel frame
- 1 Stainless steel drawer
- 10 golden tubs 24-carat
- Front panels made galvanized steel
- Plinth coated made galvanized steel
- compressor unit
- Coated frames
- 3M Di-Noc Wood finishes

The **pozzetti counter with glycol refrigeration system**, developed by Tekneitalia over 15 years ago, is a reliable and efficient solution for gelato preservation. Thanks to the high performance of its refrigeration circuit, it ensures low energy consumption and constant temperature control, making it ideal for overnight storage without compromising product quality.

With a **load capacity of 100 kg**, it features a **professional control system** for precise temperature management and **integrated refrigeration units**. The **Silestone® Cosentino** surface guarantees durability and easy cleaning, while the front panels in **painted galvanized steel** with high-resistance finishes complete the structure, combining robustness with essential aesthetics.



Pozzetti counter top in Silestone®

Dim: **W**x**L**x**H**

inch: **40,1** x **63** x **37**

cm: **102** x **160** x **94**

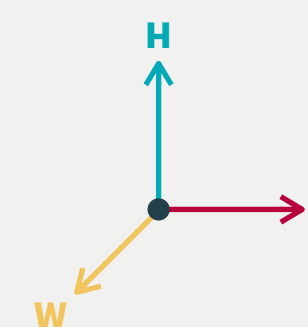



## 3 - POZZETTI COUNTERS

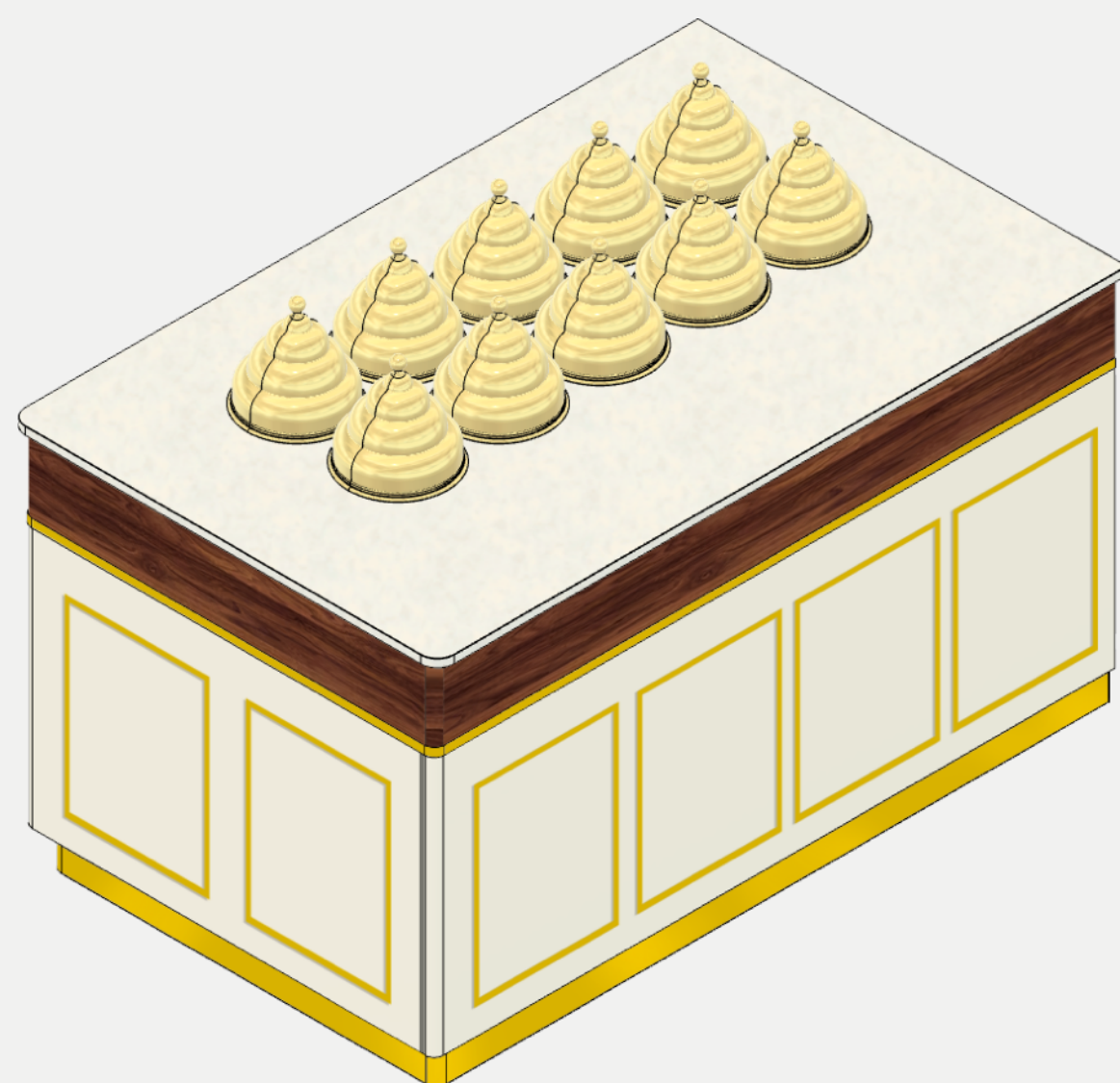

- Stainless steel frame
- 1 Stainless steel drawer
- 10 golden tubs 24-carat
- Front panels made galvanized steel
- Plinth coated made galvanized steel
- compressor unit
- Coated frames
- 3M Di-Noc Wood finishes
- side finishing panel

The **pozzetti counter with glycol refrigeration system**, developed by Tekneitalia, is a reliable and efficient solution for gelato preservation. Thanks to the high performance of its refrigeration circuit, it ensures low energy consumption and constant temperature control, making it ideal for overnight storage without compromising product quality.

With a **load capacity of 100 kg**, it features a **professional control system** for precise temperature management and **integrated refrigeration units**. The **Silestone® Cosentino** surface guarantees durability and easy cleaning, while the front panels in **painted galvanized steel** with high-resistance finishes complete the structure, combining robustness with essential aesthetics.



Pozzetti counter top in Silestone®

Dim: **W**x**L**x**H**

inch: **40,1** x **64,5** x **37**

cm: **102** x **164** x **94**

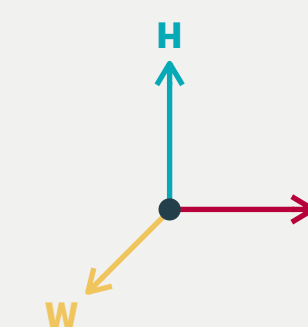

## 4 - BACK COUNTER CABINET

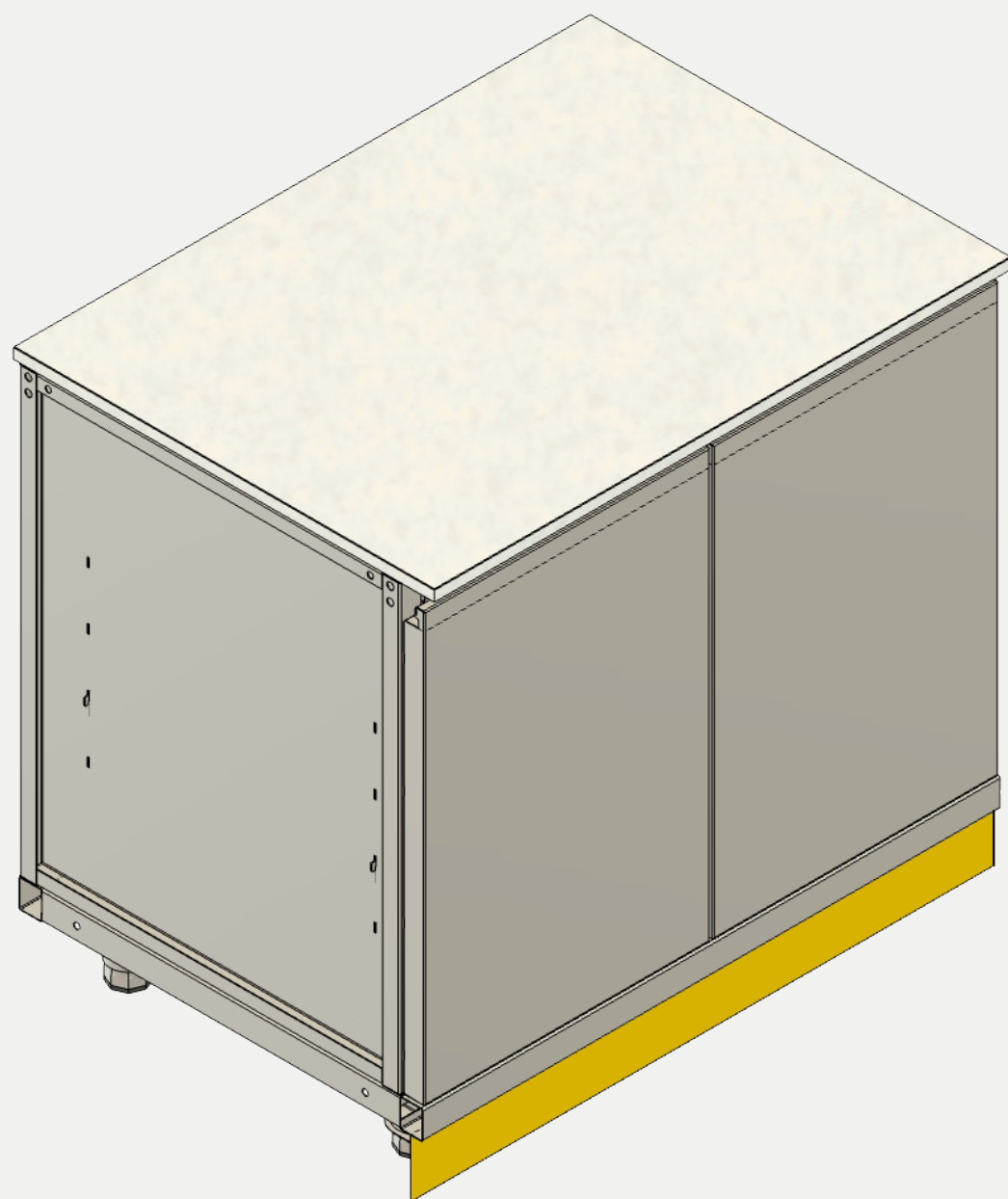

- Stainless steel frame
- 1 Stainless steel shelves
- 2 Stainless steel Cabinet doors
- Plinth coated made galvanized steel

The neutral back counter, with a **fully stainless steel frame**, is designed to ensure efficiency and organization in any operational setting. Equipped with **large stainless steel shelf, (or tailor made lay out)** it offers a durable, hygienic, and functional solution for space management. The Silestone® Cosentino surface guarantees long-lasting performance and easy cleaning. The **front doors panels**, made totally **stainless steel** material.

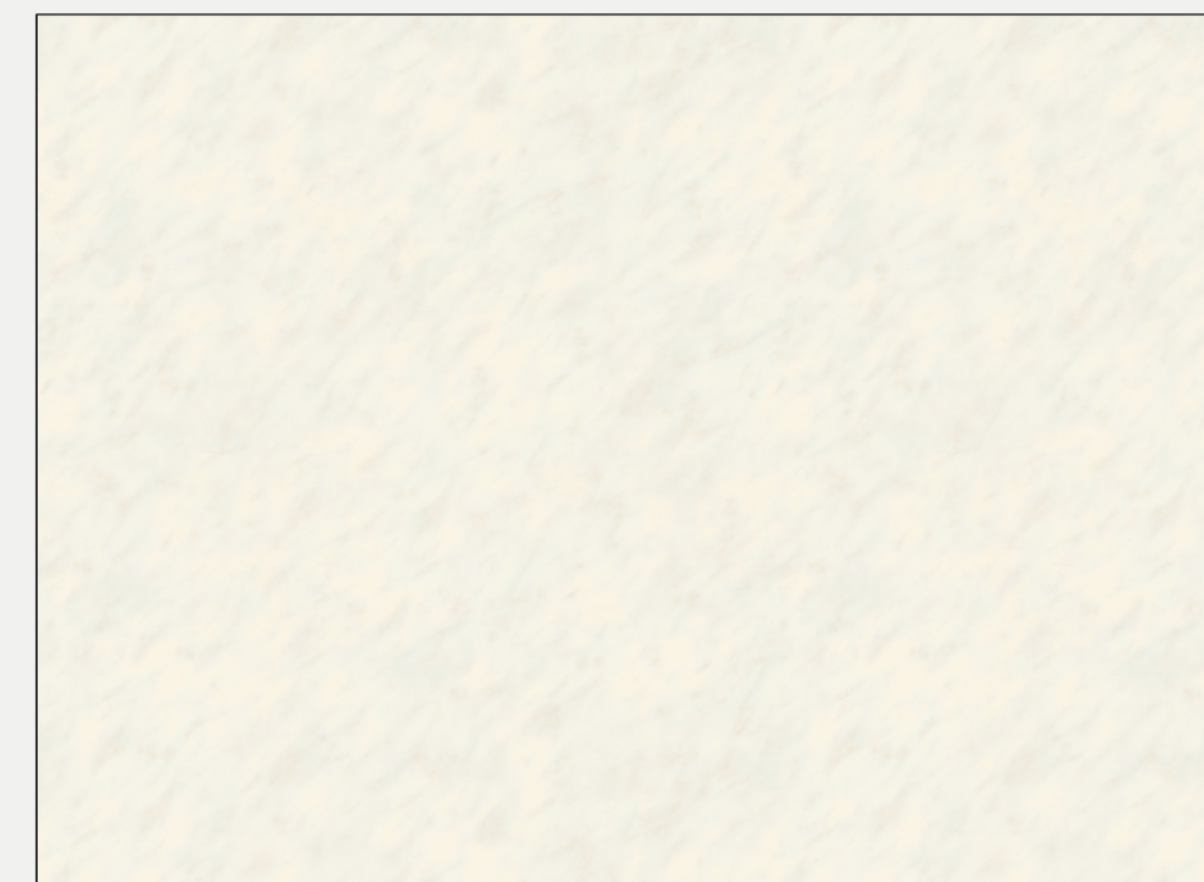

Pozzetti counter top in Silestone®

Dim: **W**x**L**x**H**

inch: **28,7** x **39,4** x **37**

cm: **73** x **100** x **94**

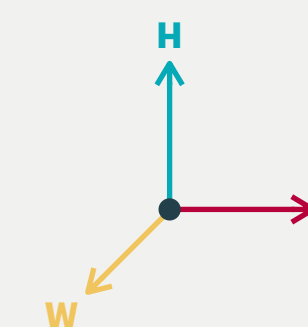

 5 - BACK COUNTER 3 DOORS REFRIGERATED

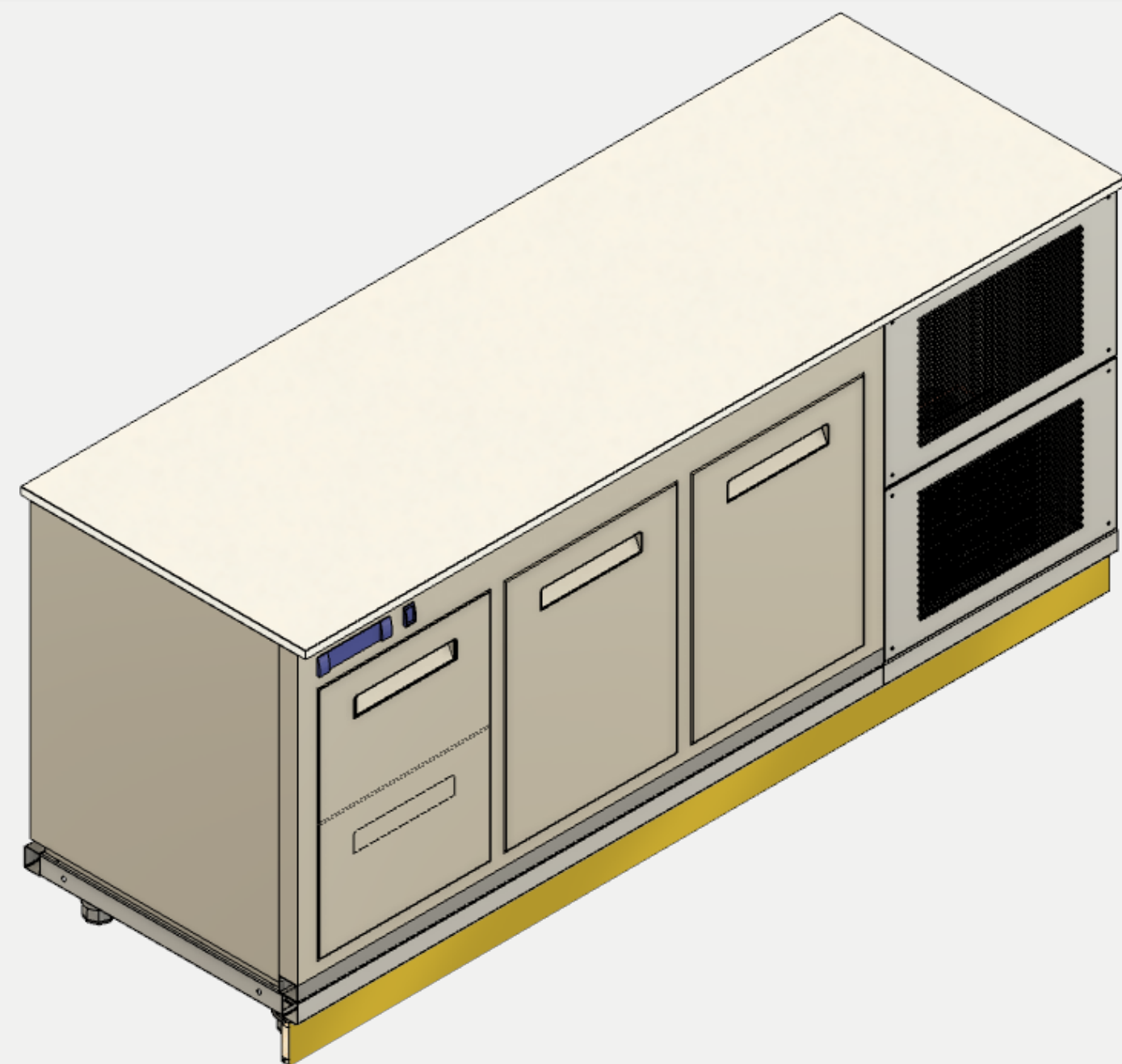

- Stainless steel frame
- 3 Doors refrigerated cabinet
- compressor unit
- Plinth coated made galvanized steel

The refrigerated cell, with a fully stainless steel structure, is designed to ensure maximum hygiene, durability, and reliability. Equipped with an **on-board refrigeration unit**, it provides precise temperature control in all operating conditions. The **Silestone® Cosentino** surface completes the system, offering high durability and easy cleaning.

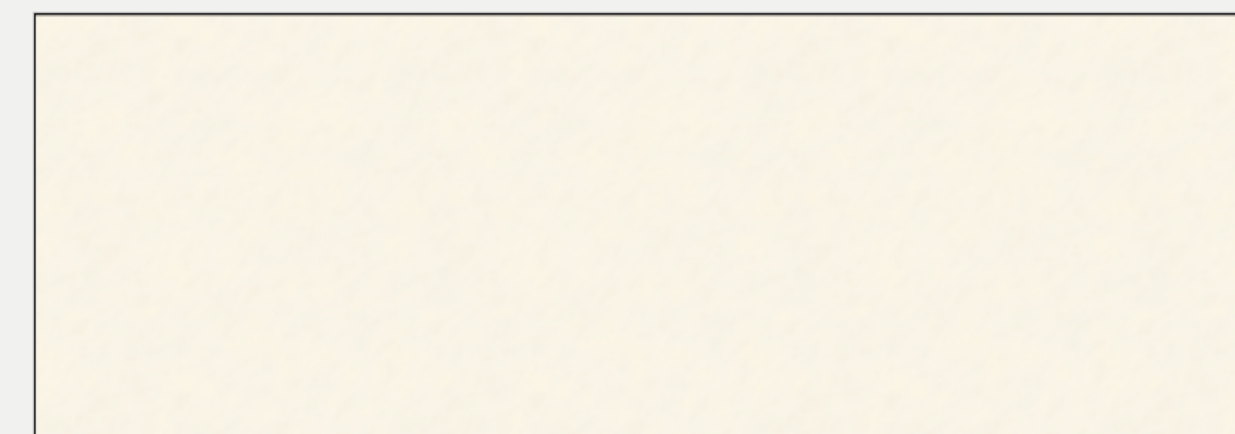

Pozzetti counter top in Silestone®

Dim: **W**x**L**x**H**

inch: **28,7** x **82,7** x **37**

cm: **73** x **210** x **94**

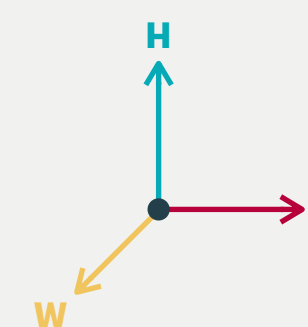

## 6 - BACK COUNTER COFFEE MACHINE

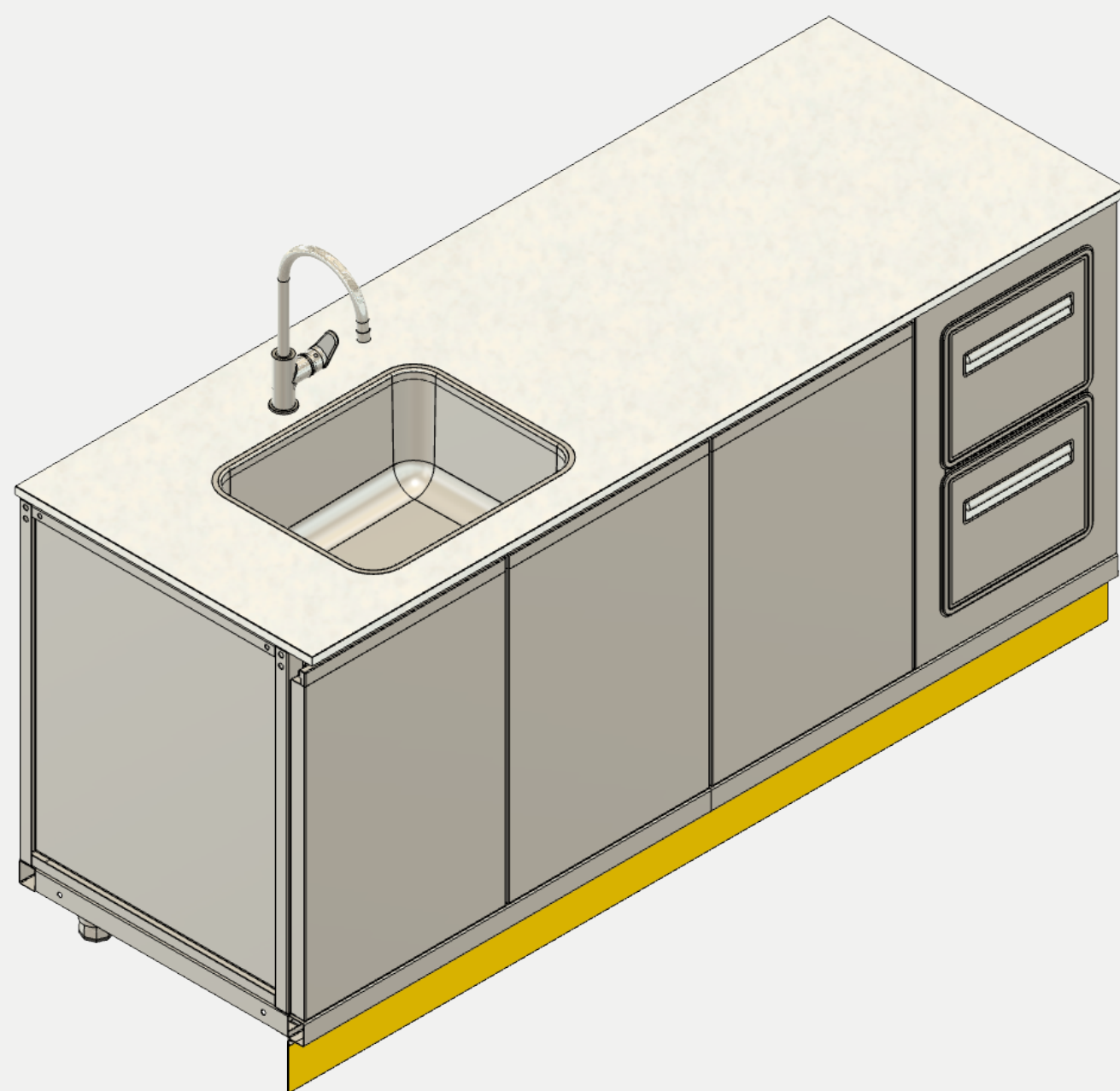

- Stainless steel frame
- 3 Stainless steel Cabinet doors
- 2 Stainless steel shelves
- Stainless steel sink and tap
- 2 coffee drawer
- Plinth coated made galvanized steel

The coffee machine back counter, made entirely of stainless steel with a stainless steel door, is designed to ensure durability, hygiene, and everyday practicality. Equipped with **two hoppers for coffee preparation**, it offers an efficient and functional solution for industry professionals.

The professional **sink unit**, with a **fully stainless steel frame and doors**, is designed to ensure durability and functionality in demanding work environments. Equipped with a **large sink** and **professional faucet**, it combines practicality and ease of use while remaining **elegant and visually appealing to the public**. The **Silestone® Cosentino** surfaces ensure long-lasting performance, easy cleaning, and a refined look—ideal even for areas visible to customers.

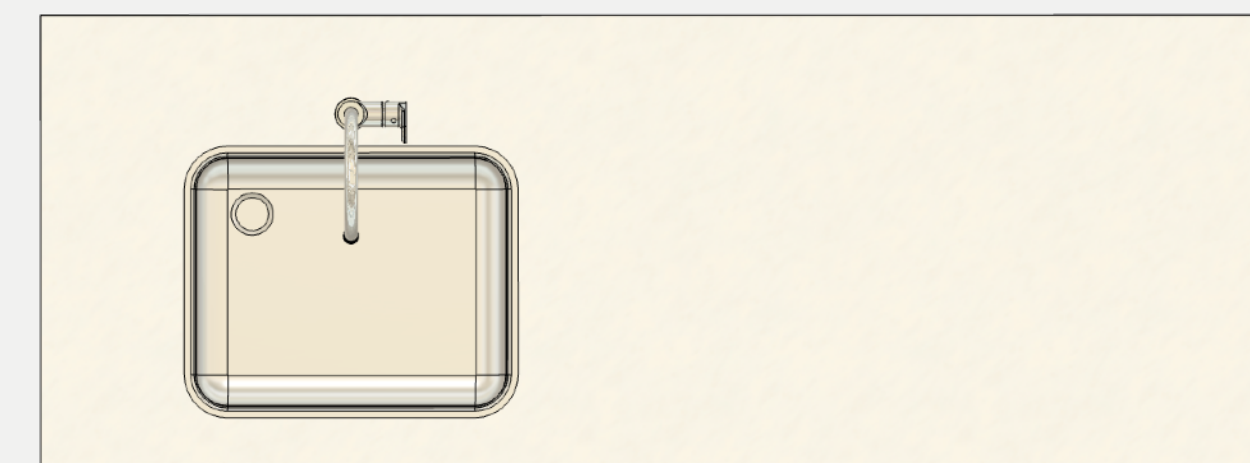

Pozzetti counter top in Silestone®

Dim: **W**x**L**x**H**  
inch: **28,7** x **78,7** x **37**  
cm: **73** x **200** x **94**

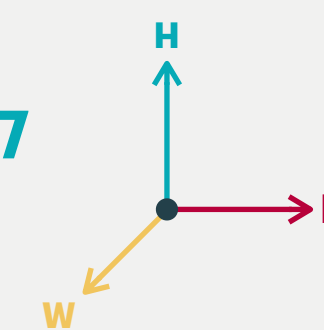

## 6 - BACK COUNTER COFFEE MACHINE

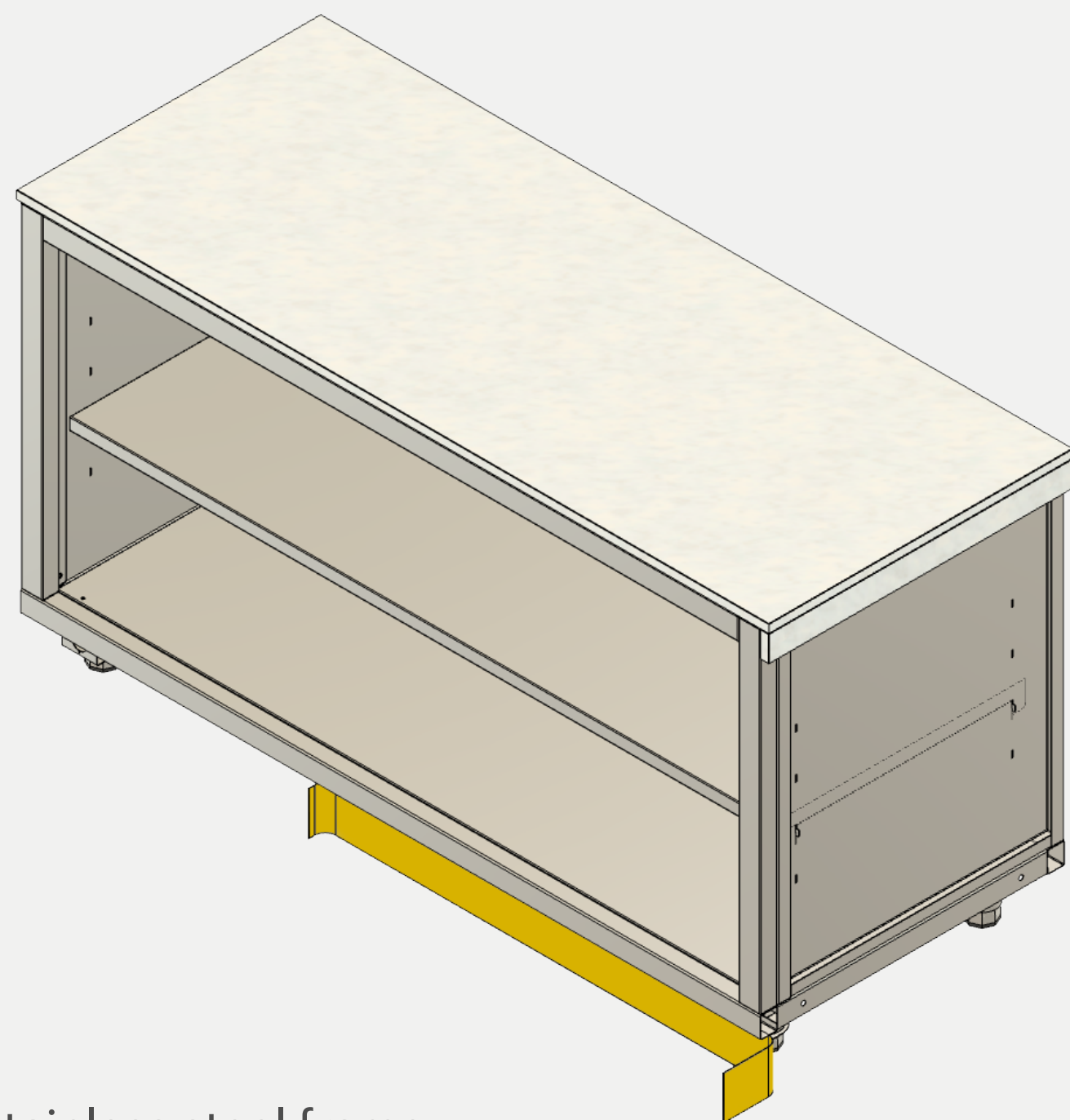

- Stainless steel frame
- 1 Stainless steel shelves
- 2 Stainless steel Cabinet doors
- Plinth coated made galvanized steel

A **fully stainless steel frame**, is designed to ensure efficiency and organization in any operational setting. Equipped with **large stainless steel shelf**, it offers a durable, hygienic, and functional solution for space management. The **Silestone® Cosentino** surface completes the system, offering high durability and easy cleaning.

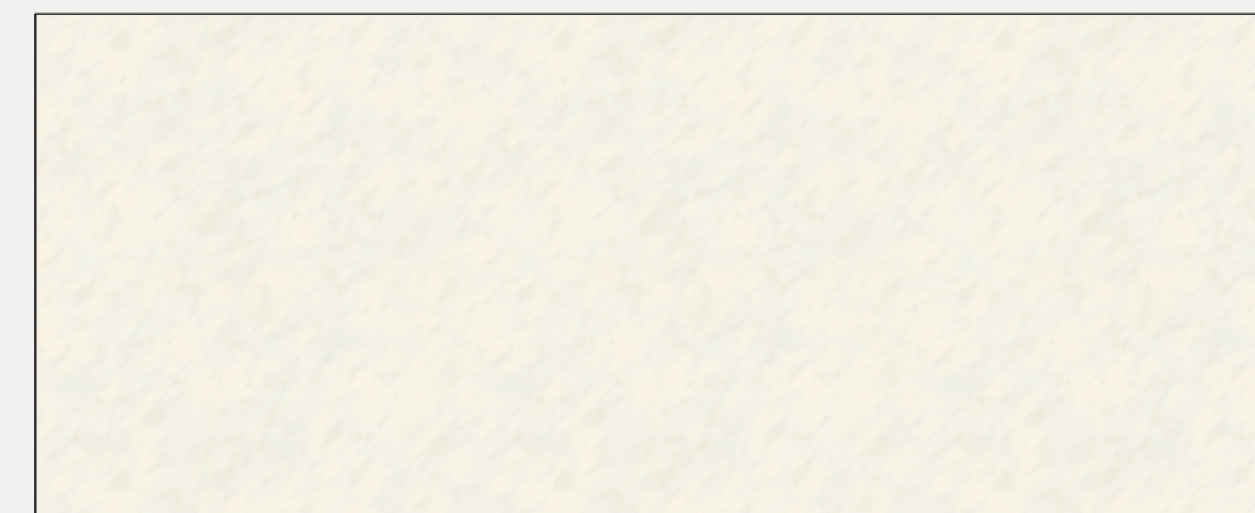

Pozzetti counter top in Silestone®

Dim: **W**x**L**x**H**

inch: **27,5** x **67,3** x **37**

cm: **70** x **171** x **94**

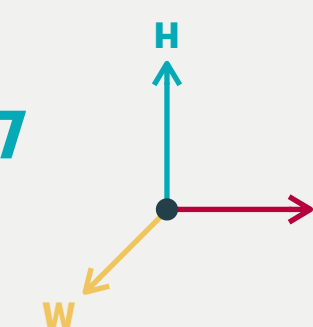



## SPLASH GUARD

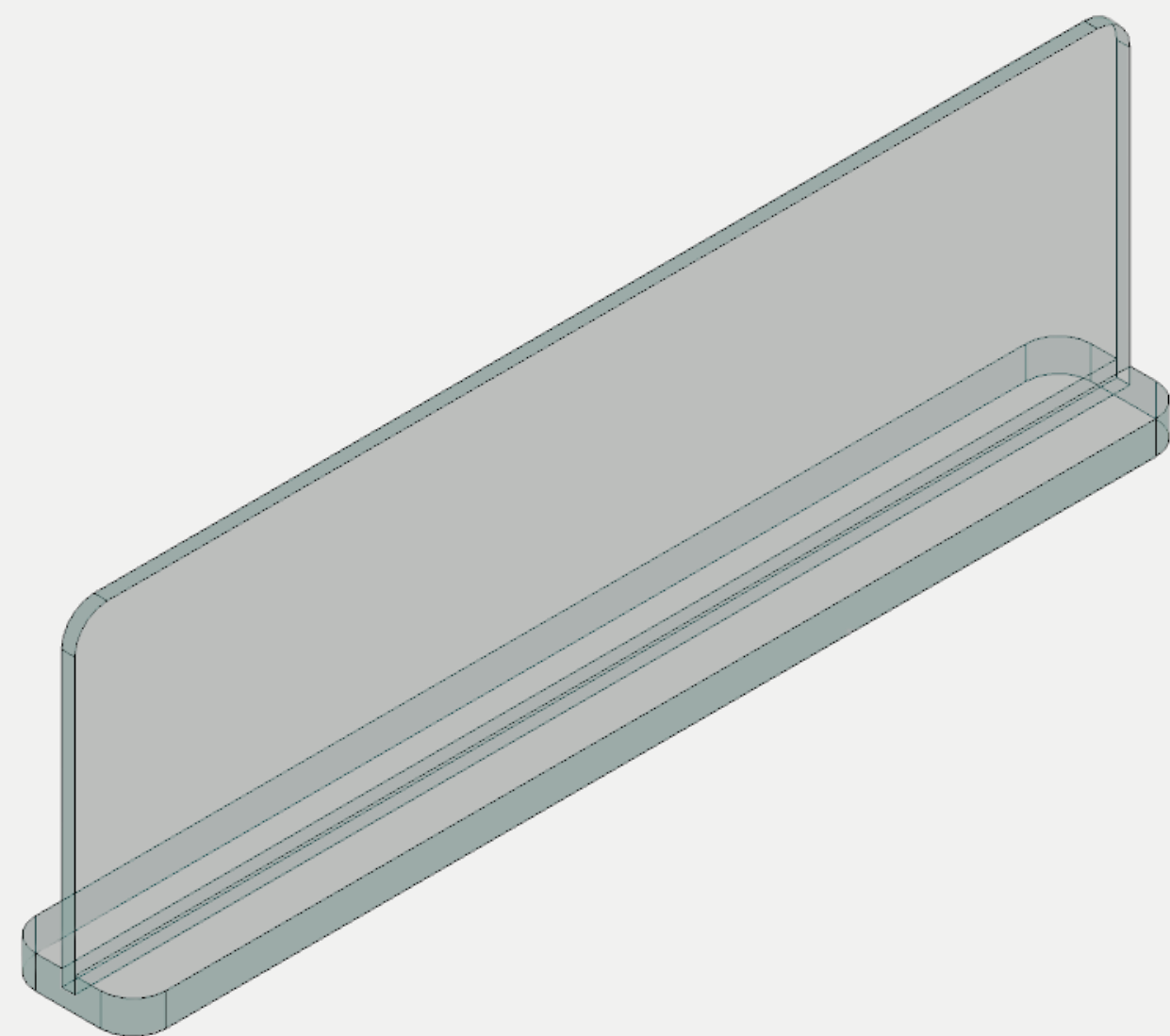

-N2 Splash Guard

### Transparent polycarbonate splash guard

Provides safe protection while keeping the work area clean, without compromising the aesthetic of the space thanks to its transparency and discreet design.

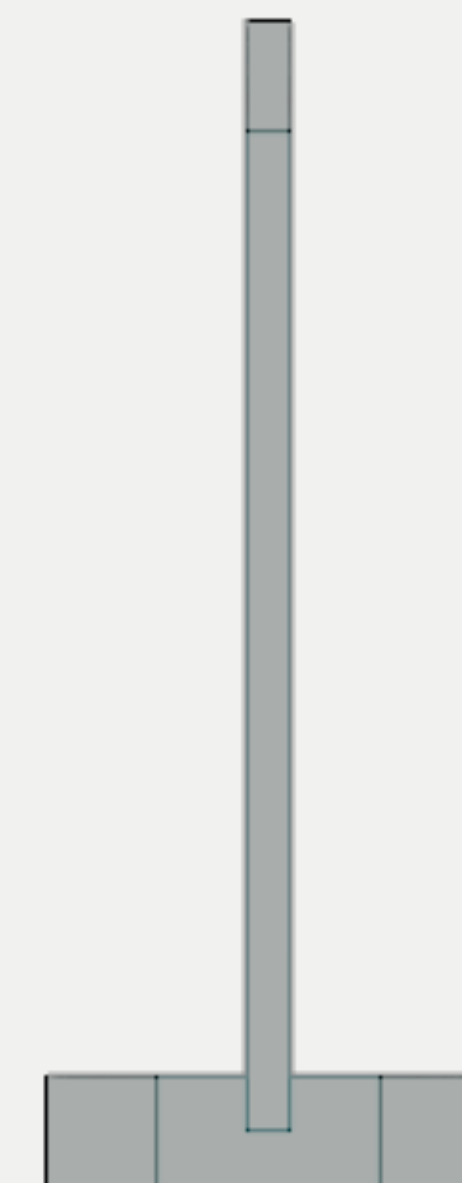

Polycarbonate

Dim: **W**x**L**x**H**

inch: **27,5** x **4,7** x **8,7**

cm: **70** x **12** x **22**

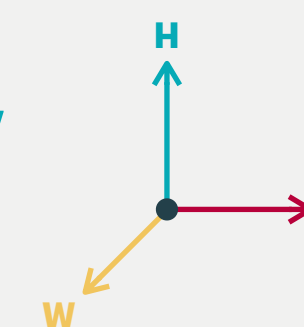



## I RIVESTIMENTI: I PIANI

# silestone®

By COSENTINO®

A leading brand for over 30 years that inspires designs for kitchens, bathrooms and commerciale surfaces.

**25 Years warranty**  
Hybrid mineral surfaces to create innovative spaces that endure over the time.

### Advantages and properties



**Elevata resistenza ai graffi**  
l'uso e l'usura quotidiana non graffiano Silestone.

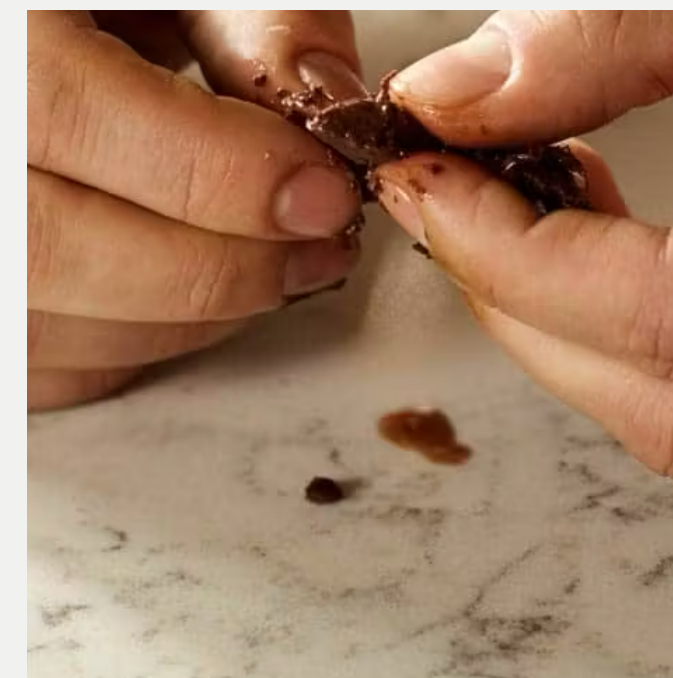

**Elevata resistenza alle macchie**  
La bassa porosità li rende altamente resistenti alle macchie.



**Alta resistenza agli urti**  
Altamente resistente agli impatti quotidiani.

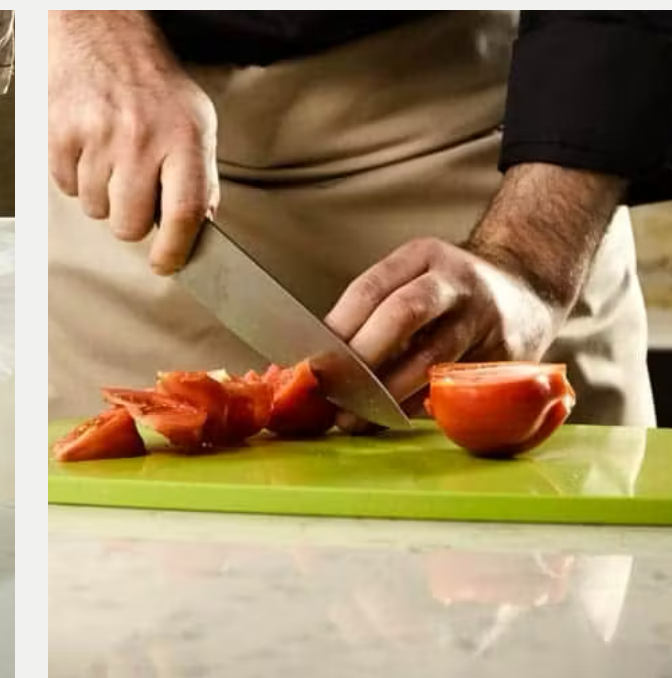

**Elevata resistenza agli acidi**  
La bassa porosità gli impedisce di essere danneggiato da macchie aggressive.

### Finish



**Polished**  
More vibrant and intense colors and reflections

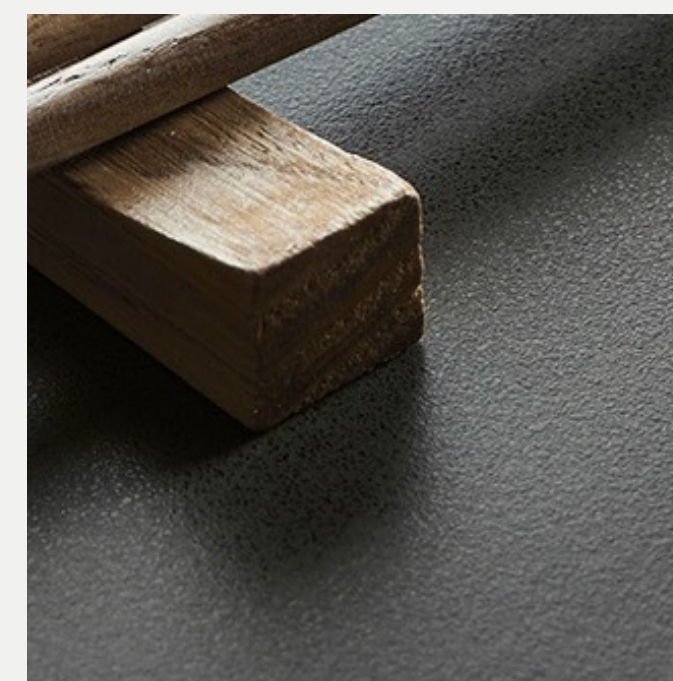

**Suede**  
Soft and pleasant feel with full color consistency

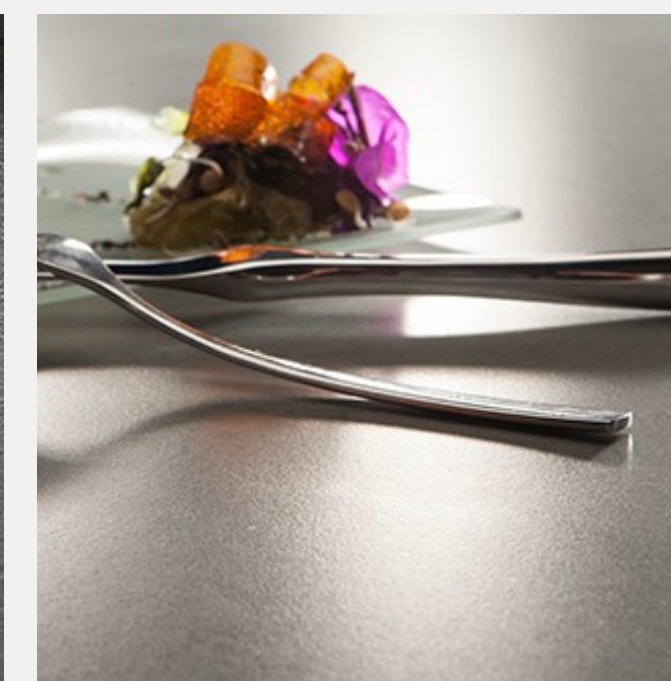

**Mate**  
Solid and satin color

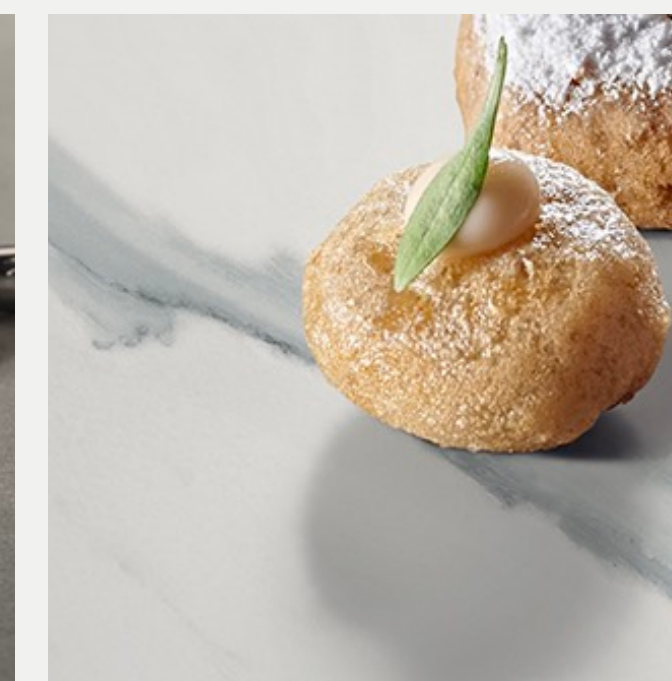

**Velvet**

## Maintenance



Click the colors to see them in use

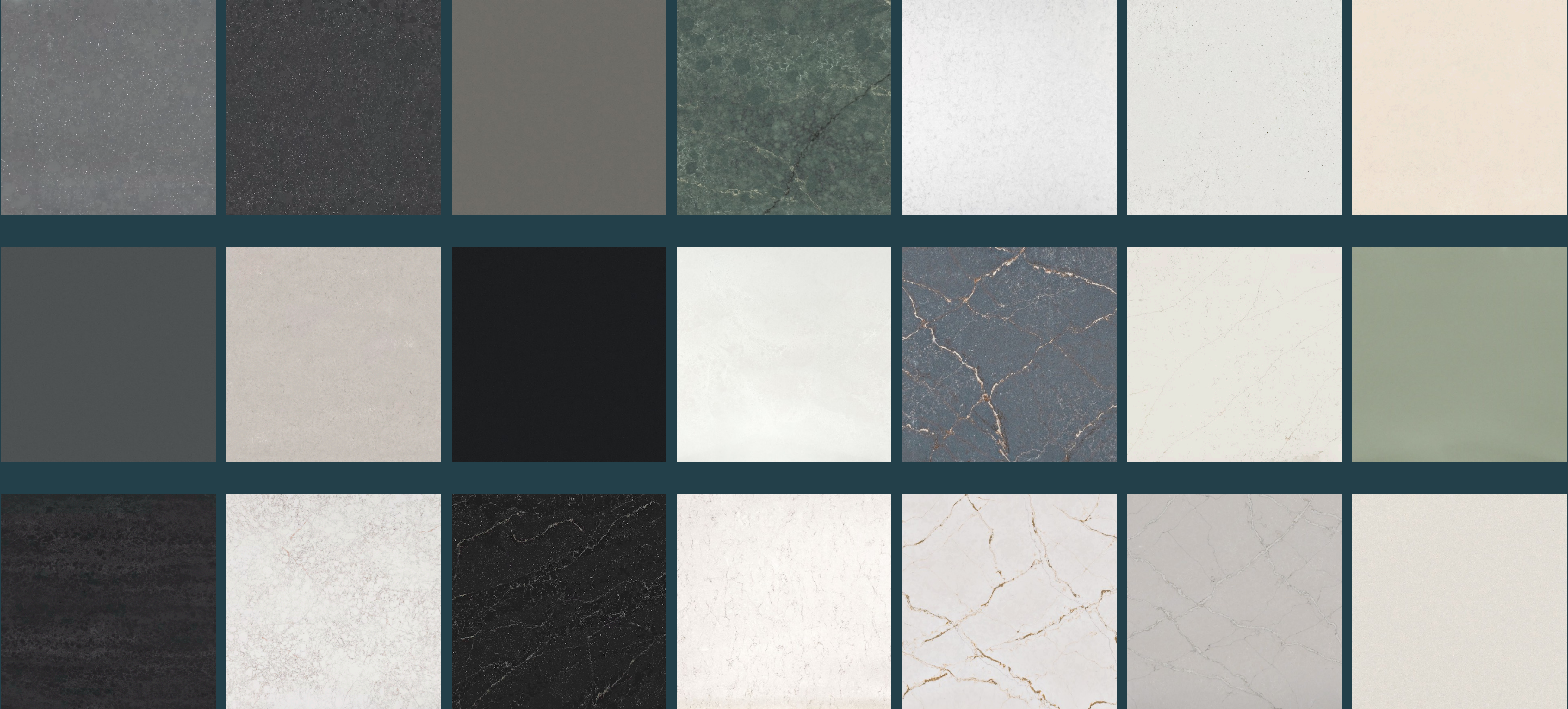

 **COLORS WITHOUT LIMITS**



[RAL Chart](#)

**PANTONE®**

[Pantone Chart](#)

**kerakoll**

[Kerakoll Chart](#)

With TekneItalia, you're never confined to a preset color palette. **We offer access to thousands of colors** through internationally recognized systems like **RAL** and **PANTONE\***, ensuring your customization is truly **limitless**. Whatever shade you envision, we can bring it to life—without compromises and without boundaries.

 **COLORS WITHOUT LIMITS**

# 3M

# DI-NOC™

**3M™ DI-NOC™ Architectural** E-Series PO Polyolefin Film are film surface finishes that give you a range of choices as you pursue your sustainability goals. These films are made with approximately 99.5% non-PVC (non-vinyl) materials, and do not contain more than 0.5% of a polyvinyl chloride-based component. **These finishes are available in various patterns and textures – wood, plaster, concrete and more, and are a great way to upgrade your interior look without all the disruption.** 3M™ Comply™ Adhesive technology virtually eliminates air bubbles, simplifying and speeding up the application process.



**Catalogue 3M Di - NOC**



## TOTAL CUSTOMIZATION

With TekneItalia, every piece of furniture becomes a **unique expression of your brand**. **Integrated “under-surface” digital graphics, stencil techniques, and glossy or matte finishes are just some of the available options.** Thousands of combinations of materials, colors, and details allow you to create truly tailor-made solutions, with no limits to customization.





## PROMINENT DETAILS

**Laser-engraved details add depth and personality to the furniture**, with the option to be painted or finished with an elegant 24-carat gold plating. **Custom-made**, these exclusive elements transform any space, making your venue unique and **instantly recognizable**.



THIS IS A **TEKNEITALIA**® PROJECT

**Tekneitalia** is a company founded **over 15 years ago** with the clear and ambitious goal of revolutionizing the way business is done in the HO.RE.CA. sector. Through **carts and mobile devices with iconic and highly recognizable design**, we have made **beauty a tool for work**. From day one, our mission has been to offer clients **not only functional tools but true extensions of their identity**: objects capable of expressing **values, emotions**, and visions through a refined and **timeless aesthetic**.

**TEKNEITALIA**®  
Brows our website



**TEKNEITALIA**®



**YOUR PROJECT, GUIDED BY EXPERT**

A dedicated team of **architects and graphic designers** will support you at every stage of development, working closely with you to create the best version of your project. Thanks to 3D modeling in a virtual environment, you'll be able to explore every detail of your venue before implementation, choosing each element with precision and ensuring a flawless result.

Contact us and **share your needs** to discover how we can **turn your project into reality**. Receive detailed information and a personalized quote, with **no obligation**.

**[INFO@TEKNEITALIA.COM](mailto:INFO@TEKNEITALIA.COM)**

**MOBILE OFFICE: +39 328 221 34 74**

**MOBILE SALES EXPORT: + 39 366 421 23 63**

**TEKNEITALIA USA: +1 212 810 6725**