

 SHOP SIZE- 20 SQM/215 SQF

ICE CREAM SHOP





DESIGN HIGHLIGHT

The project is situated in the heart of the city and aims to create an ice cream shop that immediately stands out as a landmark. The concept envisions a vibrant, eye-catching space, visible from afar, designed to attract passersby while remaining welcoming and inviting. Every design choice is focused on highlighting the true star of the space: the gelato. The interior layout is carefully planned to support a fast **grab-and-go** service, ensuring smooth flows and a seamless experience for both customers and staff.















VIRTUAL TOUR

Discover our virtual environments: **explore in 3D the spaces designed for you**, experience immersive engagement, and make confident decisions. **Find the right inspiration** to create a tailor-made, innovative, and unique venue.



Virtual Tour



MOODBOARD

The architecture and interior design interact with the urban context through geometries inspired by the **classical aesthetics** of the 1960s, combined with **reflective materials** that enhance the overall presence. The **distinctive** and **fancy** color palette—**white**, evoking purity and brightness, and **metallic pink**, a vibrant contemporary tone—adds character and originality. The harmonious interplay of these colors amplifies the visual impact, creating a striking and **memorable identity** for the venue.





FLOOR PLAN

Located in the **heart of the city**, the project features a compact and functional layout designed for **fast grab-and-go** service, typical of **high-traffic urban contexts**. Behind the sales area, a small laboratory supports daily production.

The choice of **display cases** with gelato in full view creates an immediate **visual impact**, enhancing the colors and textures of the product and **capturing the attention** of passersby.

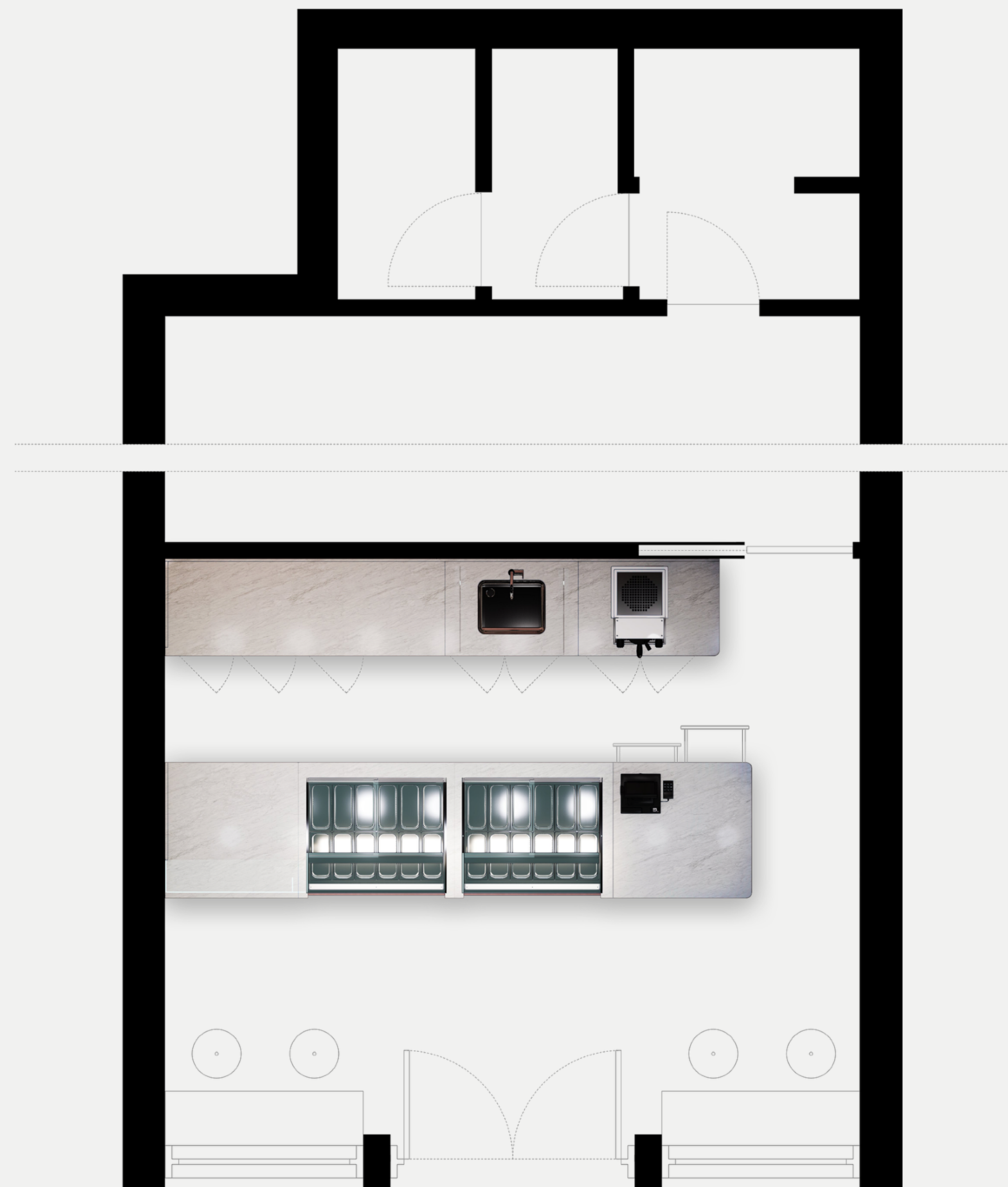



LAY-OUT

This project demonstrates how a small footprint can be transformed into a highly efficient and welcoming space. Located in the heart of a **large city**, the gelato shop unfolds within just **20 sqm/ 215 sqf** — a format designed for quick service and **high urban traffic**, guided by targeted design choices and smart commercial strategies **tailored to the metropolitan context**.

The interior layout has been carefully studied to optimize every centimeter. The **display cases**, showcasing **24 flavors**, ensure **maximum product visibility** while providing the operator with simple and direct access. The compact yet well-organized back area includes a large professional sink and a station dedicated exclusively to coffee, completing a practical, functional, and at the same time **captivating environment**.



FURNITURE LIST

Furniture list - front counters:

- 1-Checkout counter
- 2-Gelato - Ice cream Display 12 flavors
- 3-Gelato - Ice cream Display 12 flavors
- 4-Neutral counter with drawer

Furniture list - back counters:

- 5-Back counter Coffee machine
- 6-Back counter sink
- 7-Back counter Three doors refrigerated



1 - CHECKOUT COUNTER

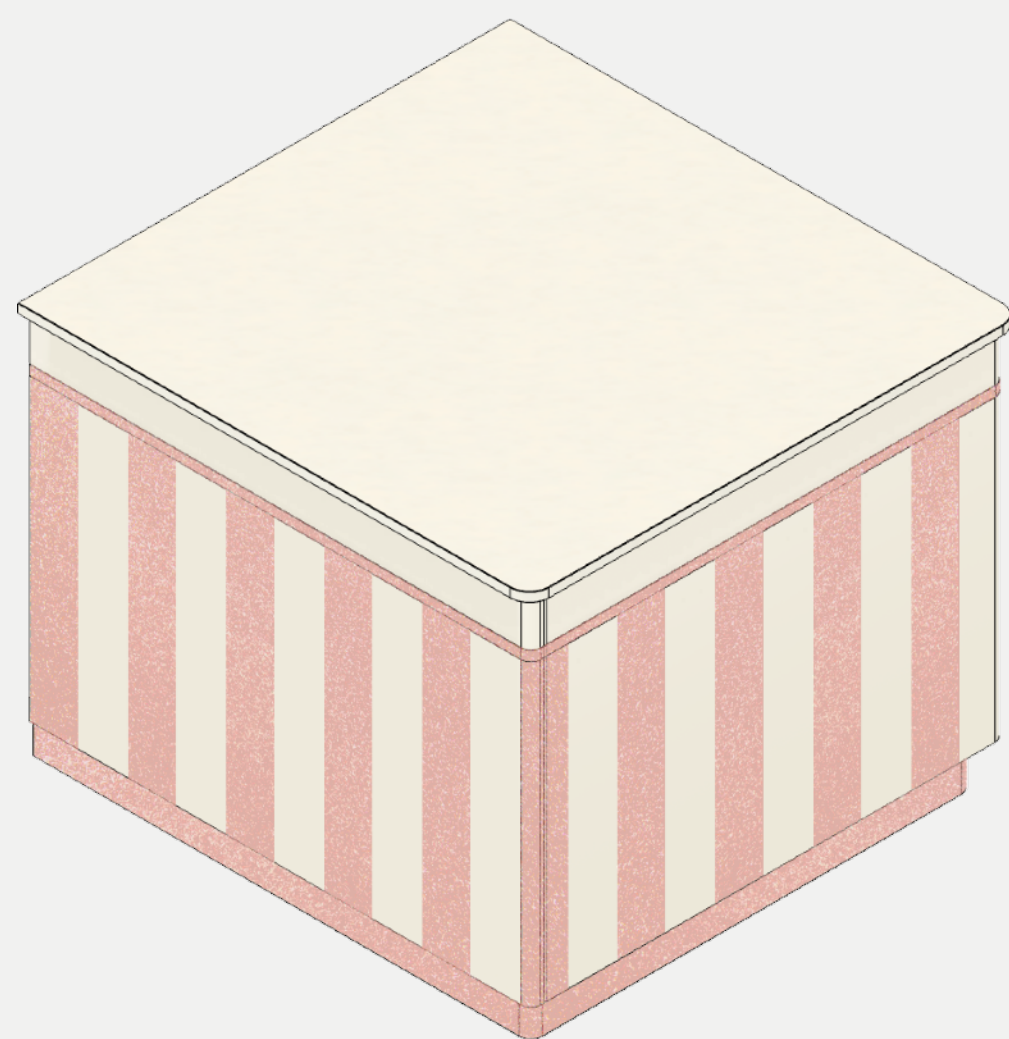

- Stainless steel frame
- 1 Stainless steel drawer
- 1 Stainless steel shelves
- Front panels made galvanized steel
- Plinth coated made galvanized steel

The checkout counter, with a **fully stainless steel frame**, is designed to ensure efficiency and organization in any operational setting. Equipped with **large stainless steel drawers and shelf**, it offers a durable, hygienic, and functional solution for space management. The Silestone[®] Cosentino surface guarantees long-lasting performance and easy cleaning, while the **front panels**, made of powder-coated galvanized steel with **high-resistance finishes**, complete the structure by combining strength with essential aesthetics.

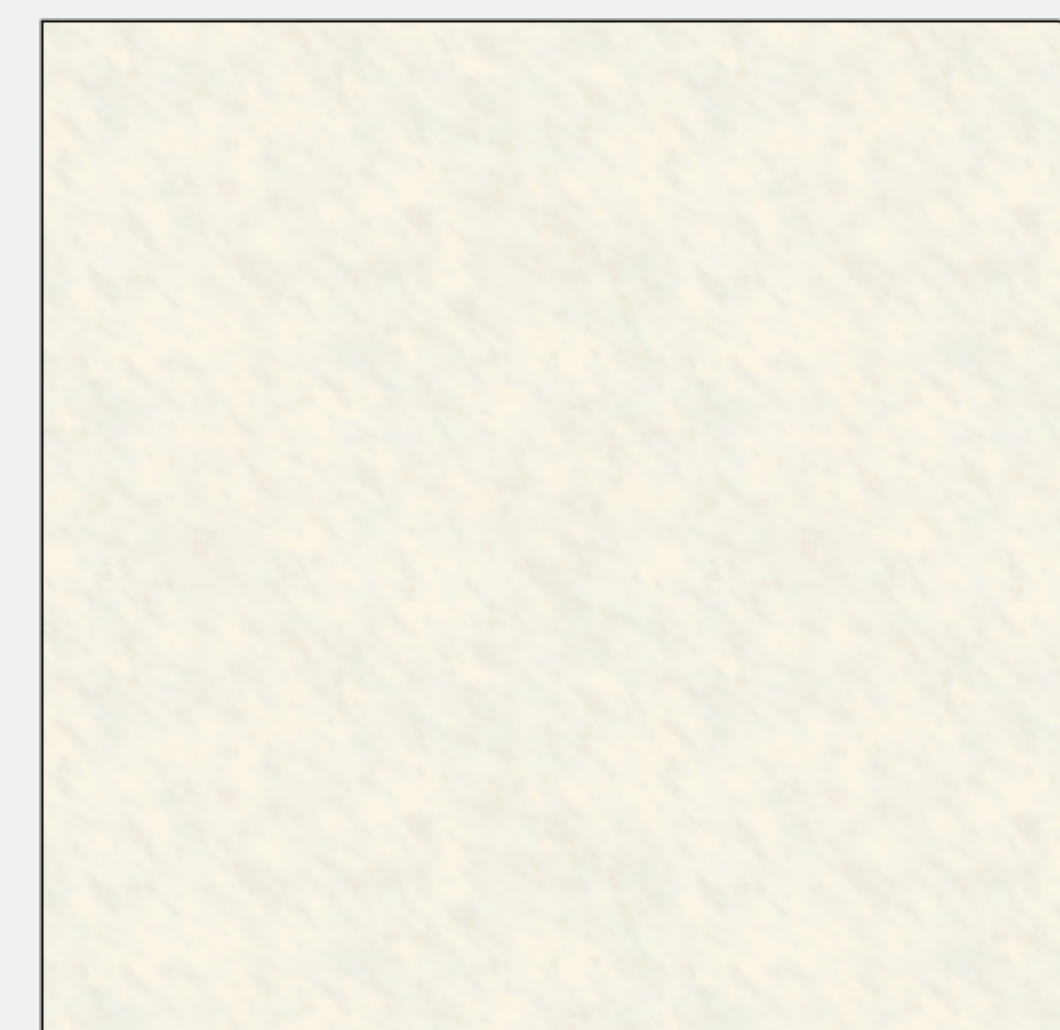

Checkout counter top in Silestone[®]

Dim: **W**x**L**x**H**

inch: **40,1** x **40,1** x **33,8**

cm: **102** x **102** x **86**

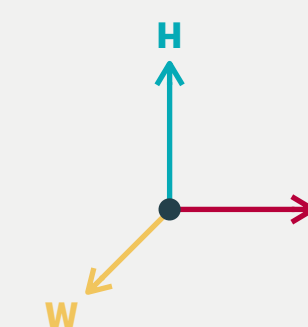



2/3 - GELATO DISPLAY

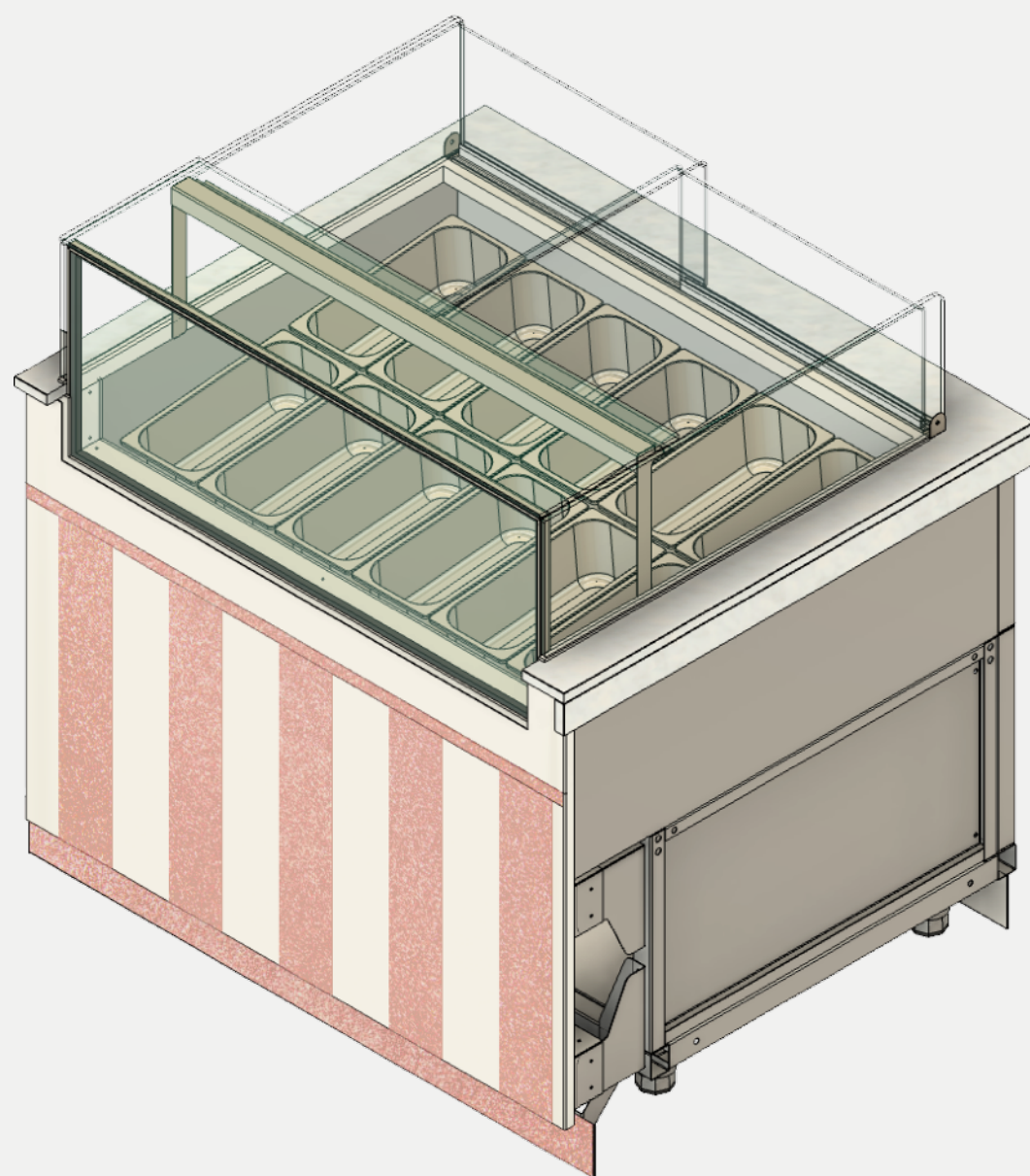

- Stainless steel frame
- 1 Stainless steel drawer
- heated double front glass
- 24 gelato display pans
- Front panels made galvanized steel
- Plinth coated made galvanized steel
- compressor unit

Ice cream display case integrated into the furniture, entirely made of stainless steel.

The heated double-glass front prevents fogging, ensuring maximum product visibility at all times. Designed with a strong focus on ergonomics, it offers customers an optimal view of the gelato while providing the operator with practicality and comfort in daily use.

With a **load capacity of 12 flavors**, it features a **professional control system** for precise temperature management and **integrated refrigeration units**. The **Silestone® Cosentino** surface guarantees durability and easy cleaning, while the front panels in **painted galvanized steel** with high-resistance finishes complete the structure, combining robustness with essential aesthetics.

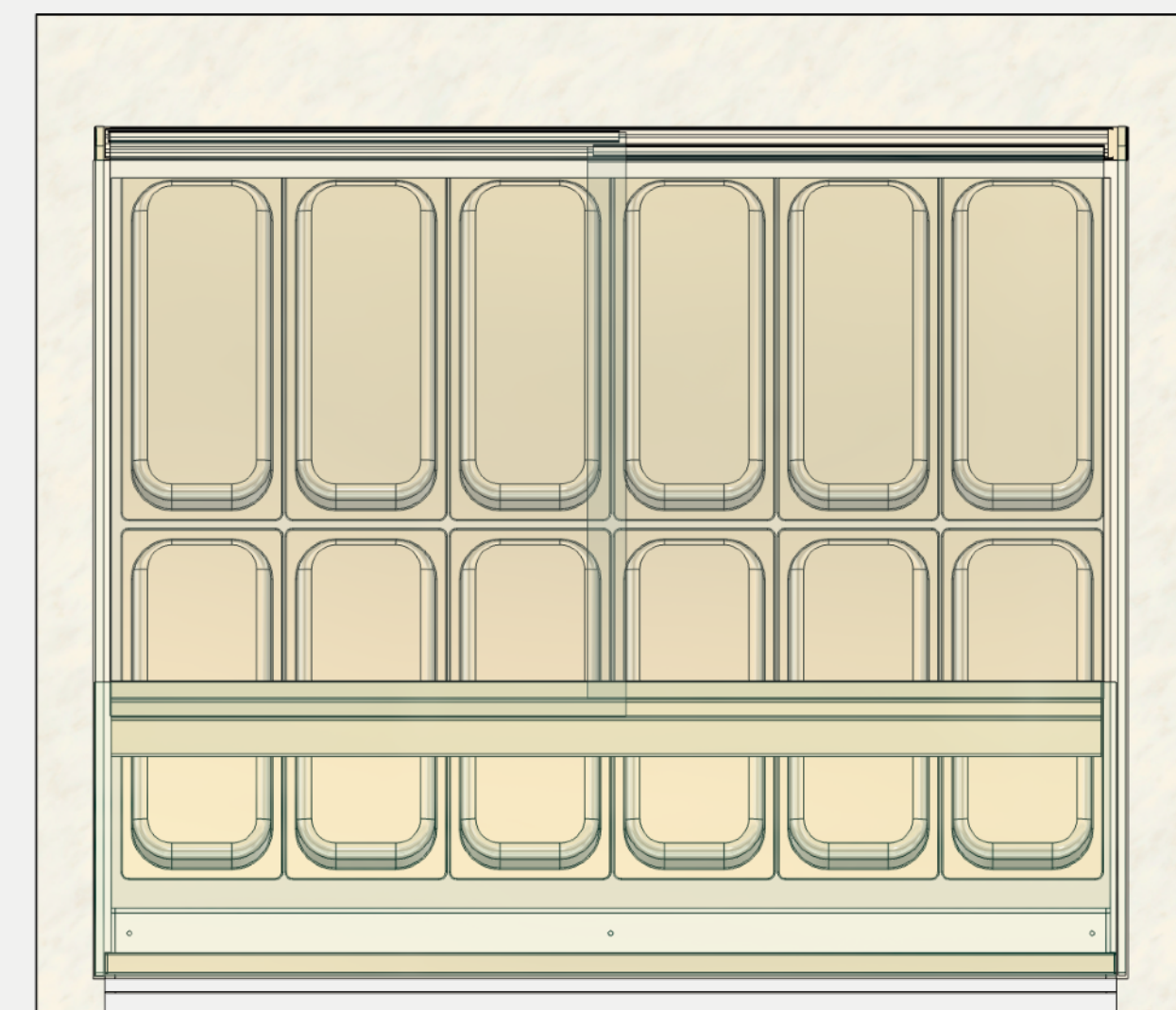

Pozzetti counter top in Silestone®

Dim: **W**x**L**x**H**
inch: **40,1** x **46,8** x **47,6**
cm: **102** x **119** x **121**

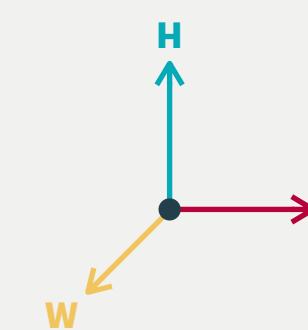



4 - NEUTRAL COUNTER

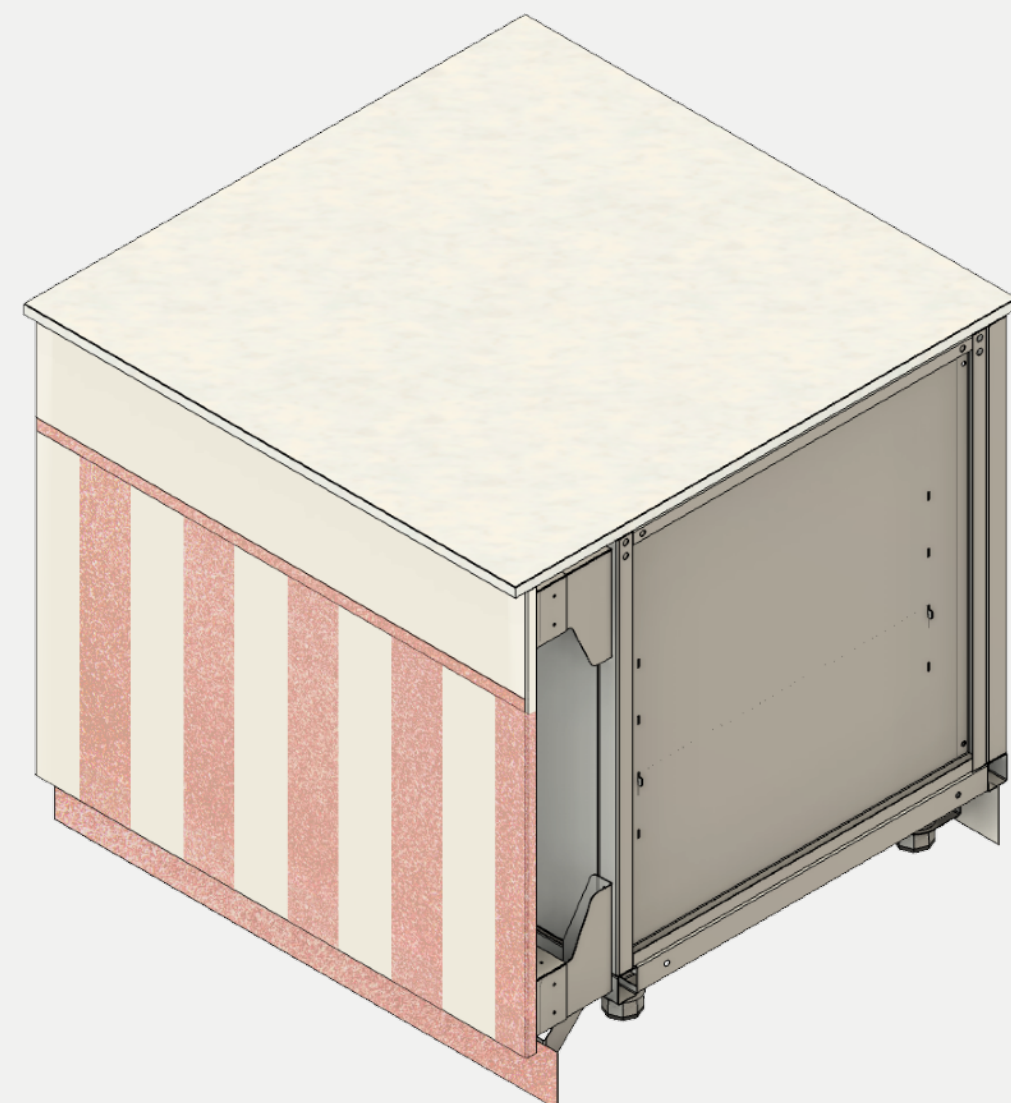

- Stainless steel frame
- 1 Stainless steel drawer
- 2 Stainless steel shelves
- Front panels made galvanized steel
- Plinth coated made galvanized steel

The neutral counter, with a **fully stainless steel frame**, is designed to ensure efficiency and organization in any operational setting. Equipped with **large stainless steel shelf, (or tailor made lay out)** it offers a durable, hygienic, and functional solution for space management. The Silestone® Cosentino surface guarantees long-lasting performance and easy cleaning, while the **front panels**, made of powder-coated galvanized steel with **high-resistance finishes**, complete the structure by combining strength with essential aesthetics.

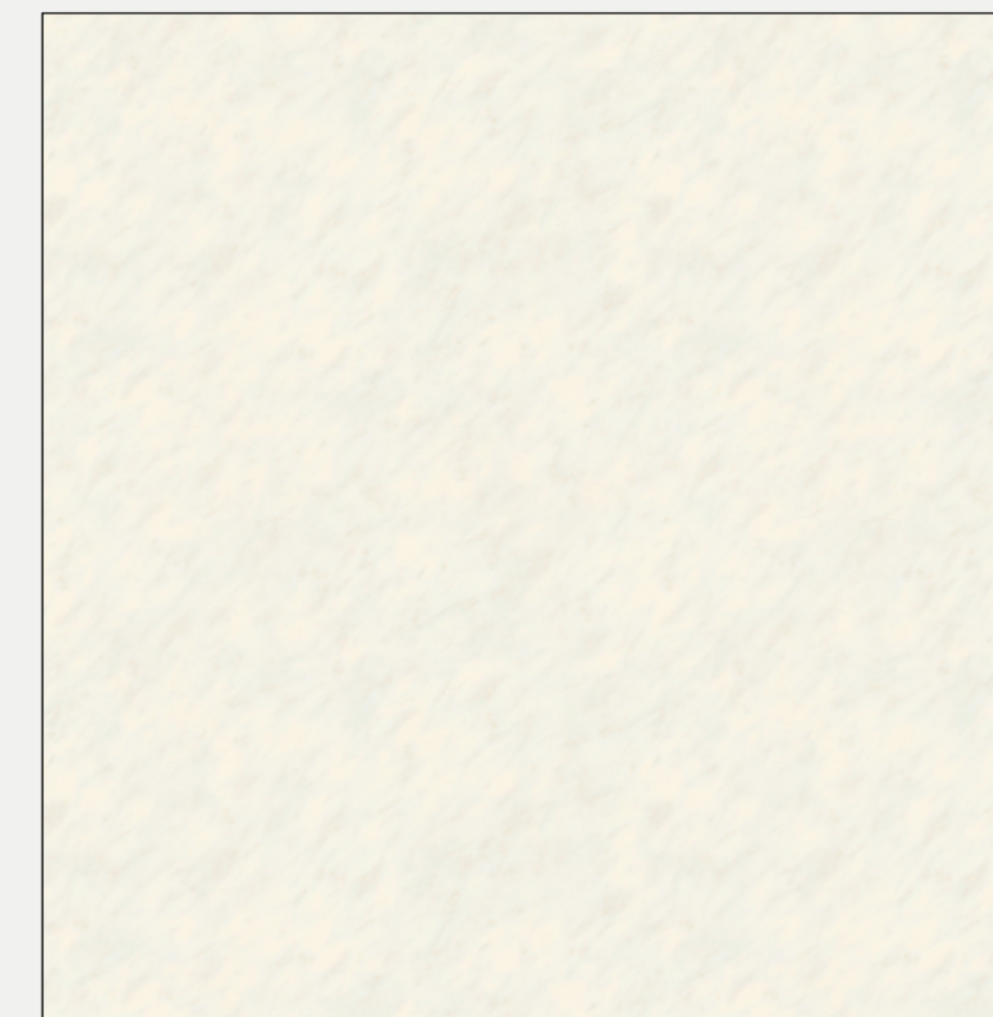

Pozzetti counter top in Silestone®

Dim: **W**x**L**x**H**

inch: **40,1** x **39,4** x **37**

cm: **102** x **100** x **94**

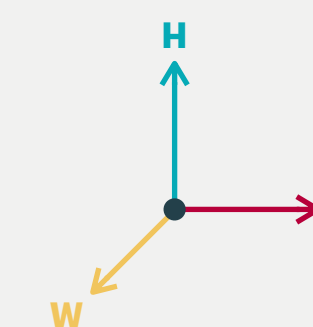

5 - BACK COUNTER COFFEE MACHINE

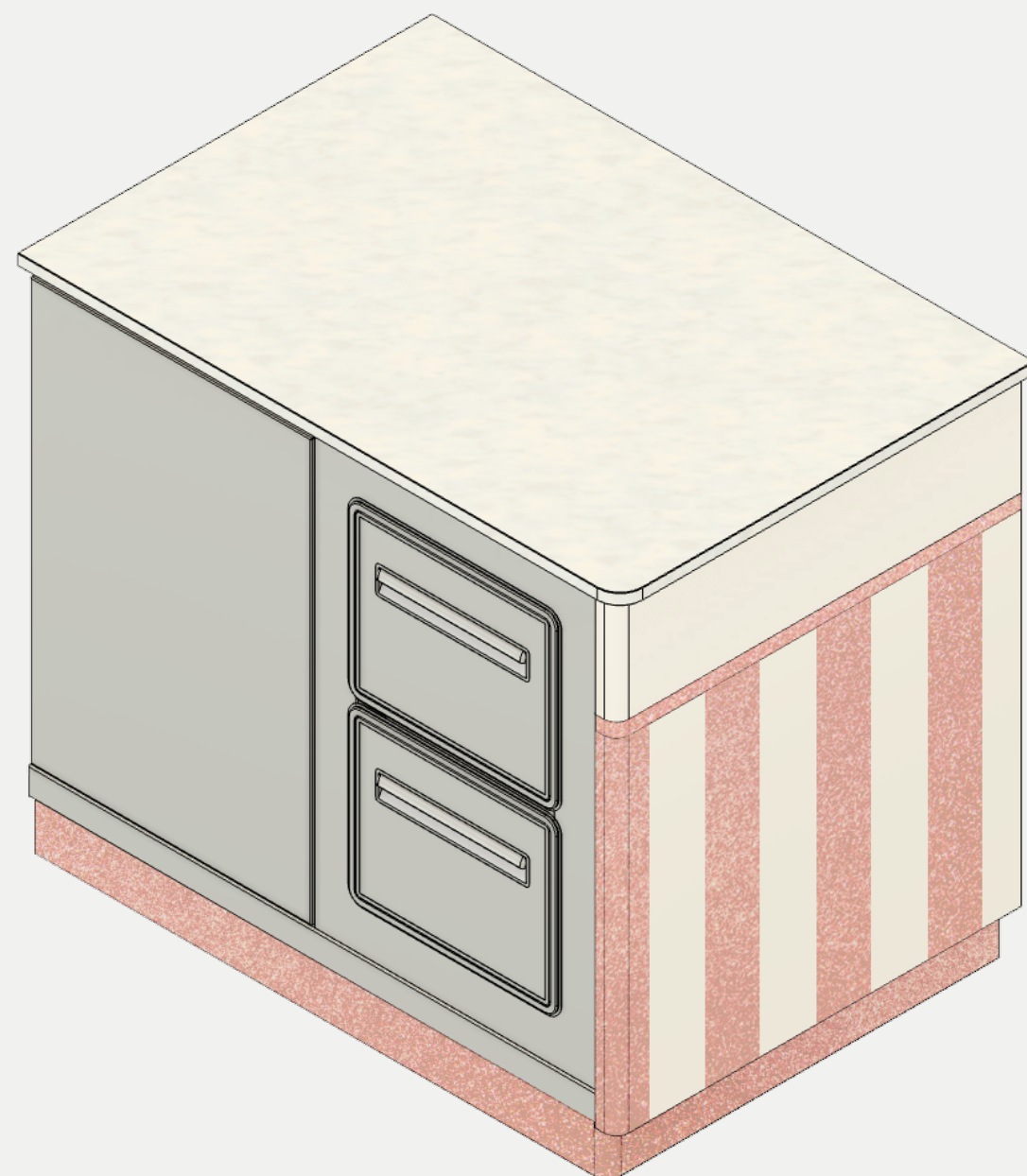

- Stainless steel frame
- 1 Stainless steel Cabinet doors
- 2 coffee drawer
- 2 Stainless steel shelves
- Plinth coated made galvanized steel

The coffee machine back counter, made entirely of stainless steel with a stainless steel door, is designed to ensure durability, hygiene, and everyday practicality. Equipped with **two hoppers for coffee preparation**, it offers an efficient and functional solution for industry professionals. The **Silestone® Cosentino** surfaces ensure long-lasting performance, easy cleaning, and a refined look—ideal even for areas visible to customers.

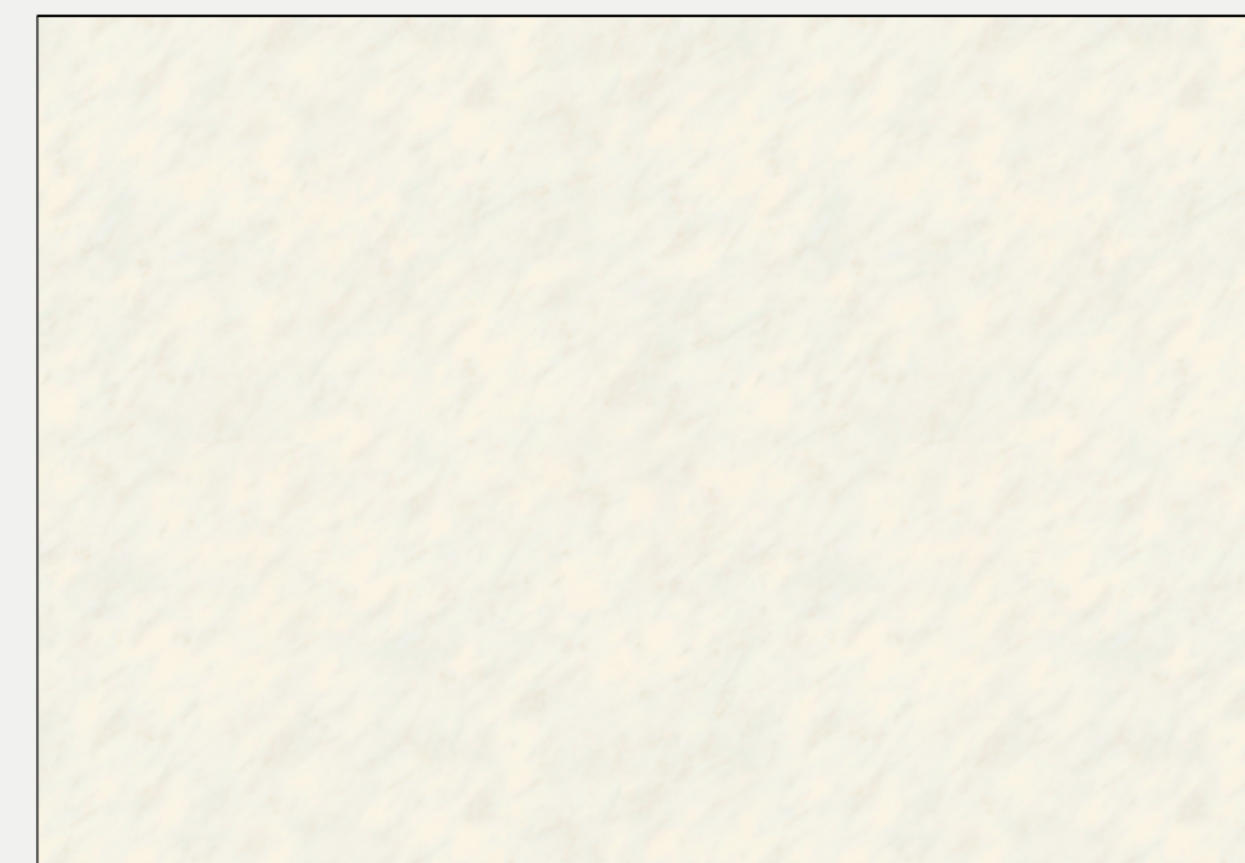

Pozzetti counter top in Silestone®

Dim: **W**x**L**x**H**

inch: **28,7** x **41,7** x **37**

cm: **73** x **106** x **94**

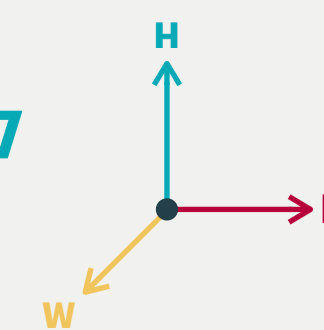



6 - BACK COUNTER SINK

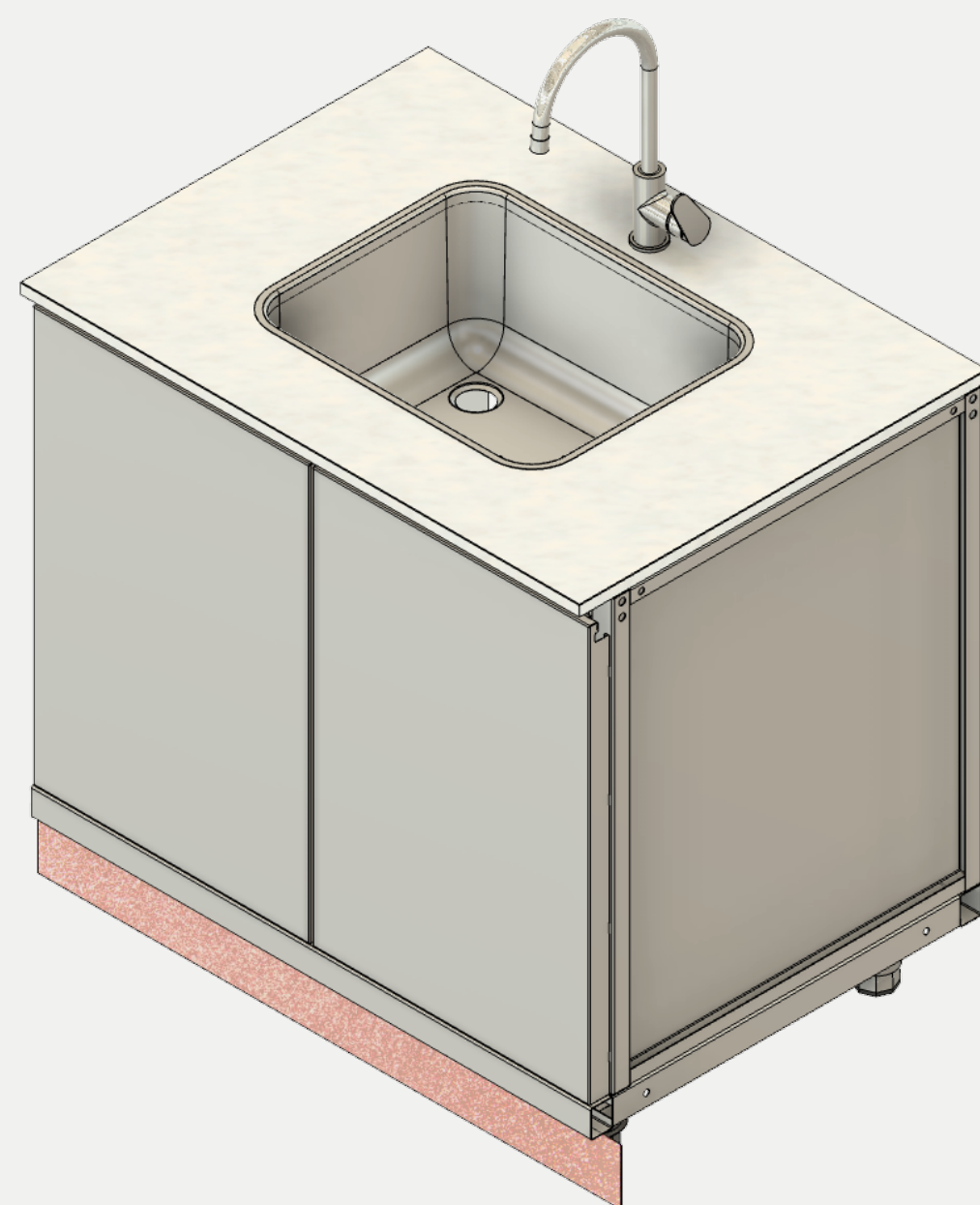

- Stainless steel frame
- 2 Stainless steel Cabinet doors
- Stainless steel sink and tap
- 2 Stainless steel doors
- Plinth coated made galvanized steel

The professional **sink unit**, with a **fully stainless steel frame and doors**, is designed to ensure durability and functionality in demanding work environments. Equipped with a **large sink** and **professional faucet**, it combines practicality and ease of use while remaining **elegant and visually appealing to the public**. The Silestone® Cosentino surface guarantees durability and easy cleaning

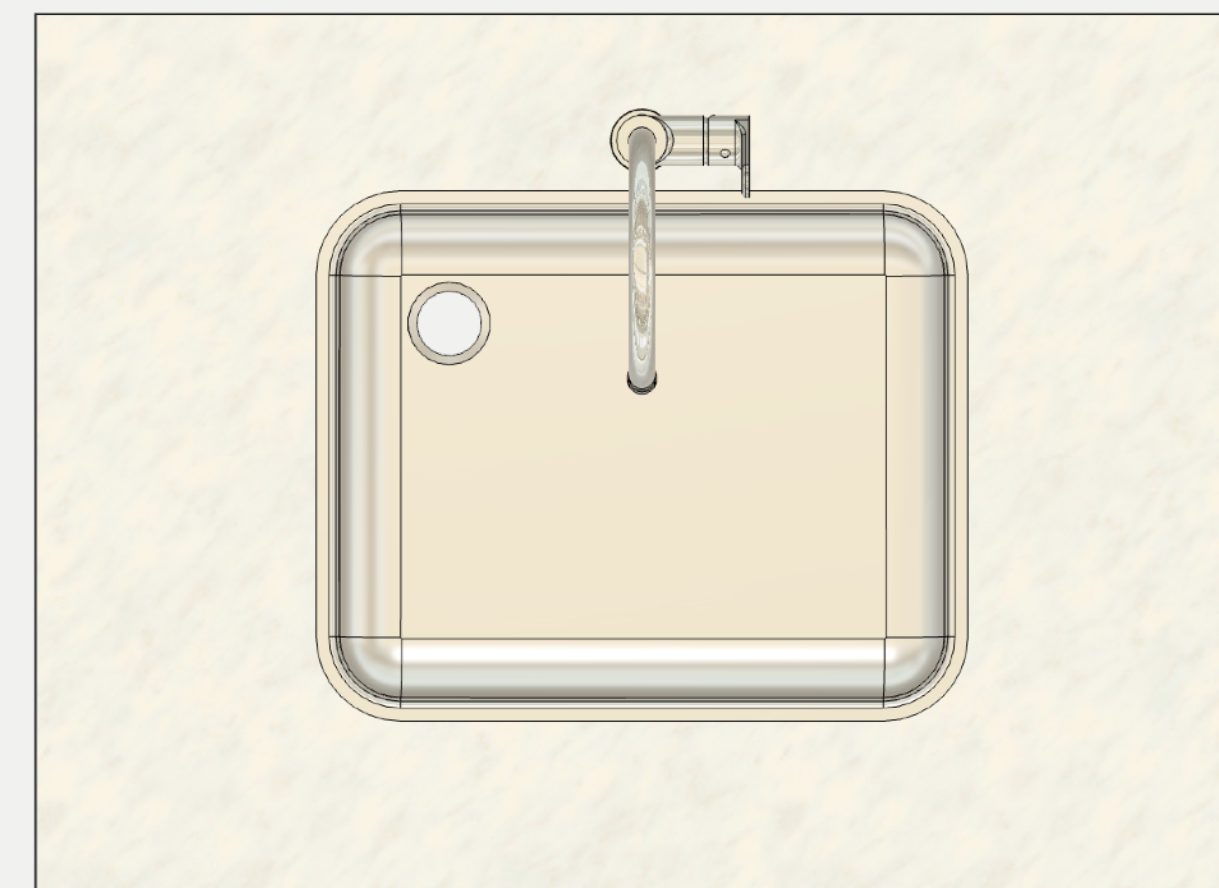



Pozzetti counter top in Silestone®

Dim: **W**x**L**x**H**

inch: **28,7** x **39,3** x **37**

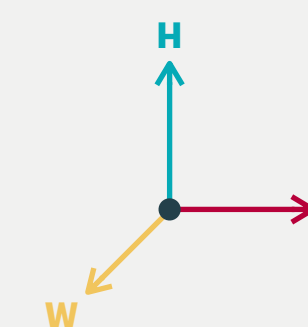
cm: **73** x **100** x **94**



 **7 - BACK COUNTER 3 DOORS REFRIGERATED**

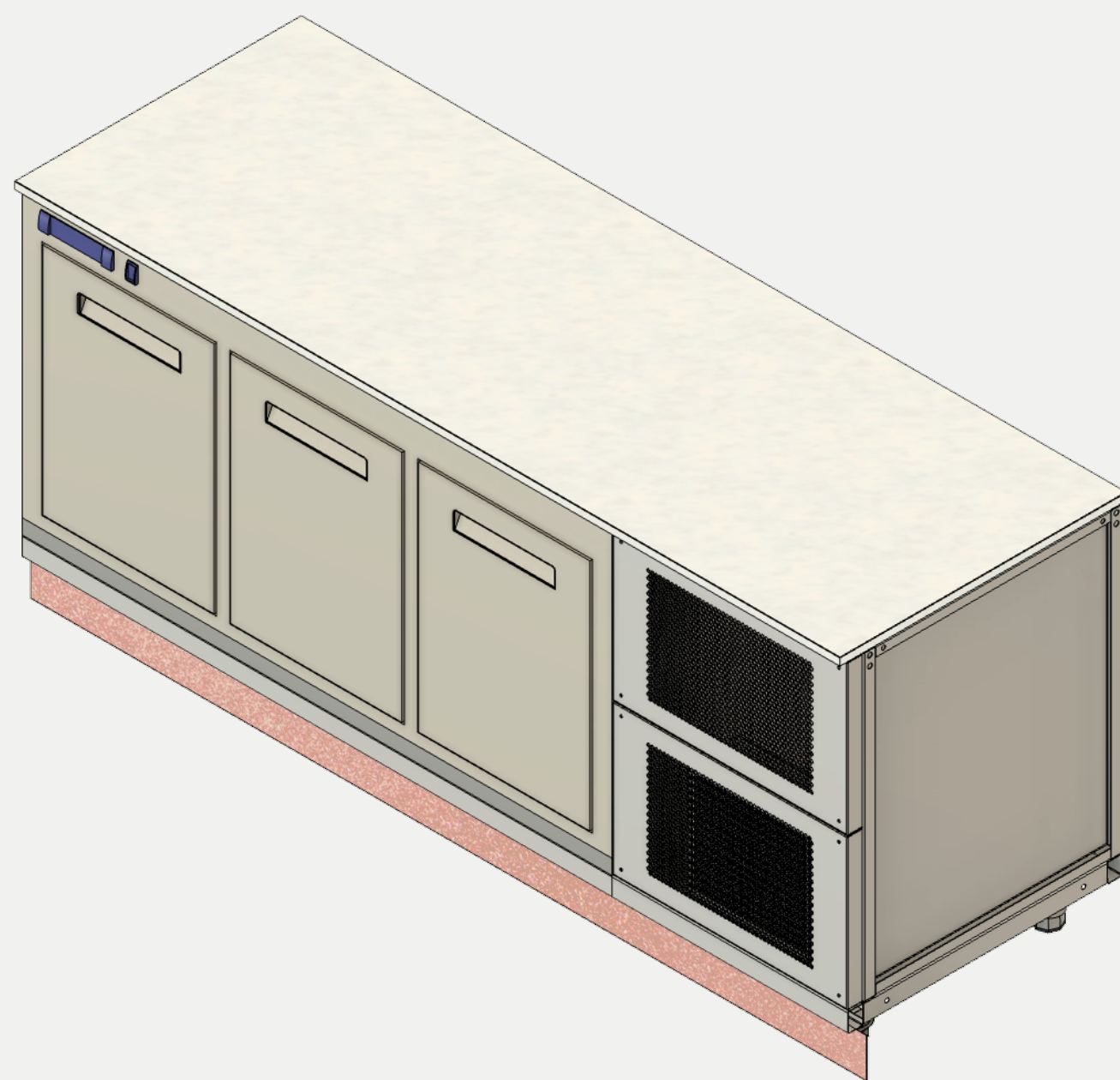

- Stainless steel frame
- 3 Doors refrigerated cabinet
- compressor unit
- Plinth coated made galvanized steel

The refrigerated cell, with a fully stainless steel structure, is designed to ensure maximum hygiene, durability, and reliability. Equipped with an **on-board refrigeration unit**, it provides precise temperature control in all operating conditions. The **Silestone® Cosentino** surface completes the system, offering high durability and easy cleaning.

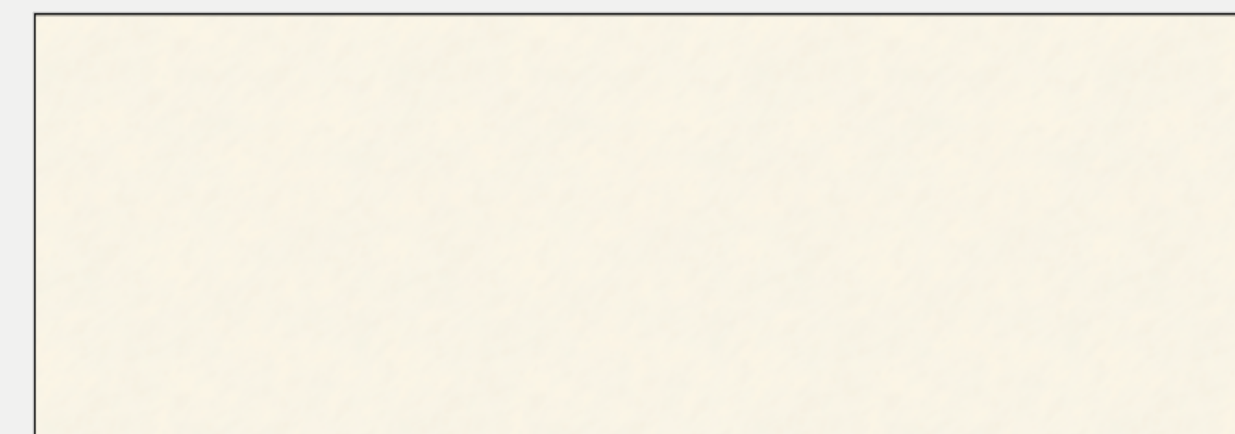

Pozzetti counter top in Silestone®

Dim: **W**x**L**x**H**
inch: **28,7** x **82,7** x **37**
cm: **73** x **210** x **94**

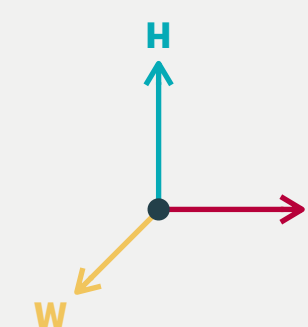

FOOD GLASS PROTECTION

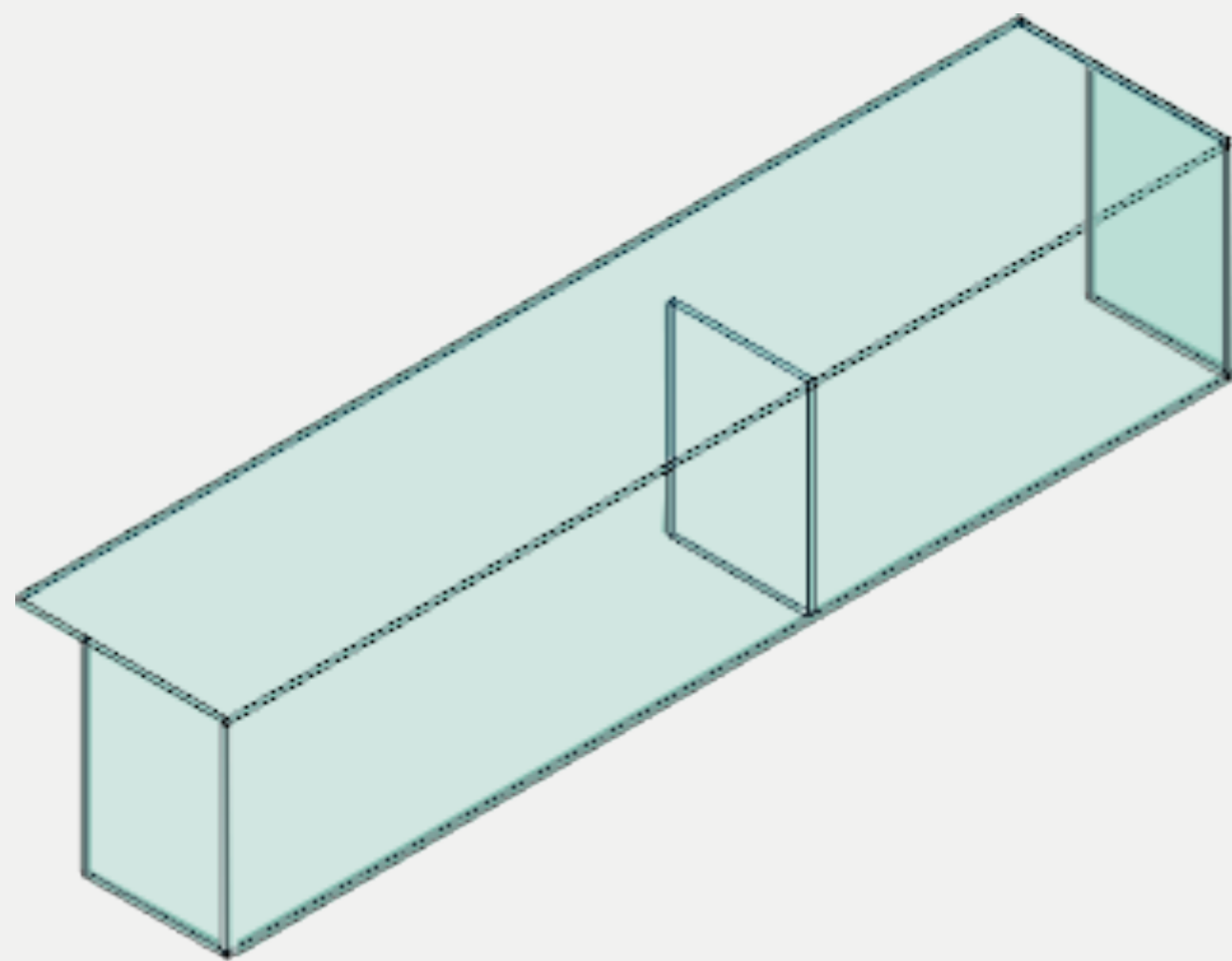

-n 2 food glass protection

The **food glass protection** is custom-made with **1 cm thick tempered glass**, ensuring maximum strength, safety, and transparency. Ideal for protecting food in professional settings, it combines functionality and elegance, perfectly adapting to any display counter.

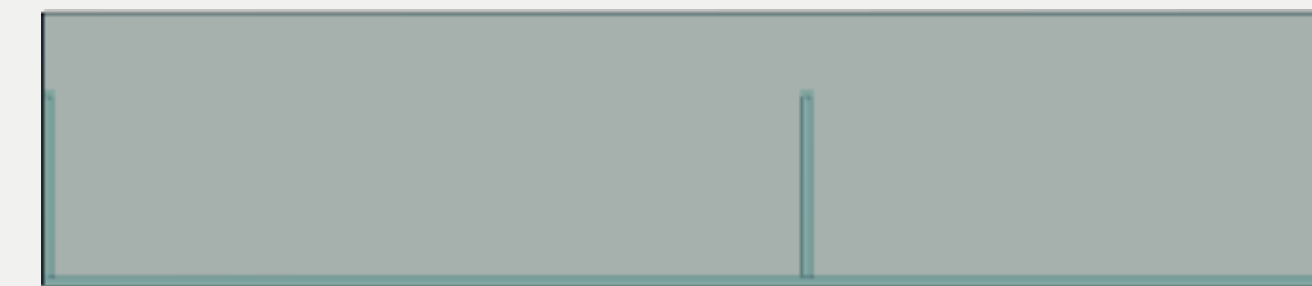

Tempered glass

Dim: **W**x**L**x**H**

inch: **125,9** x **9,8** x **9,8**

cm: **320** x **25** x **25**

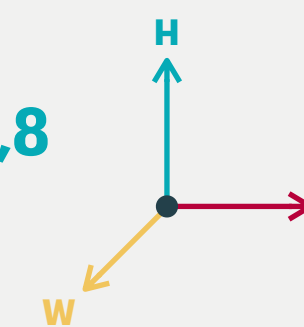



SPLASH GUARD

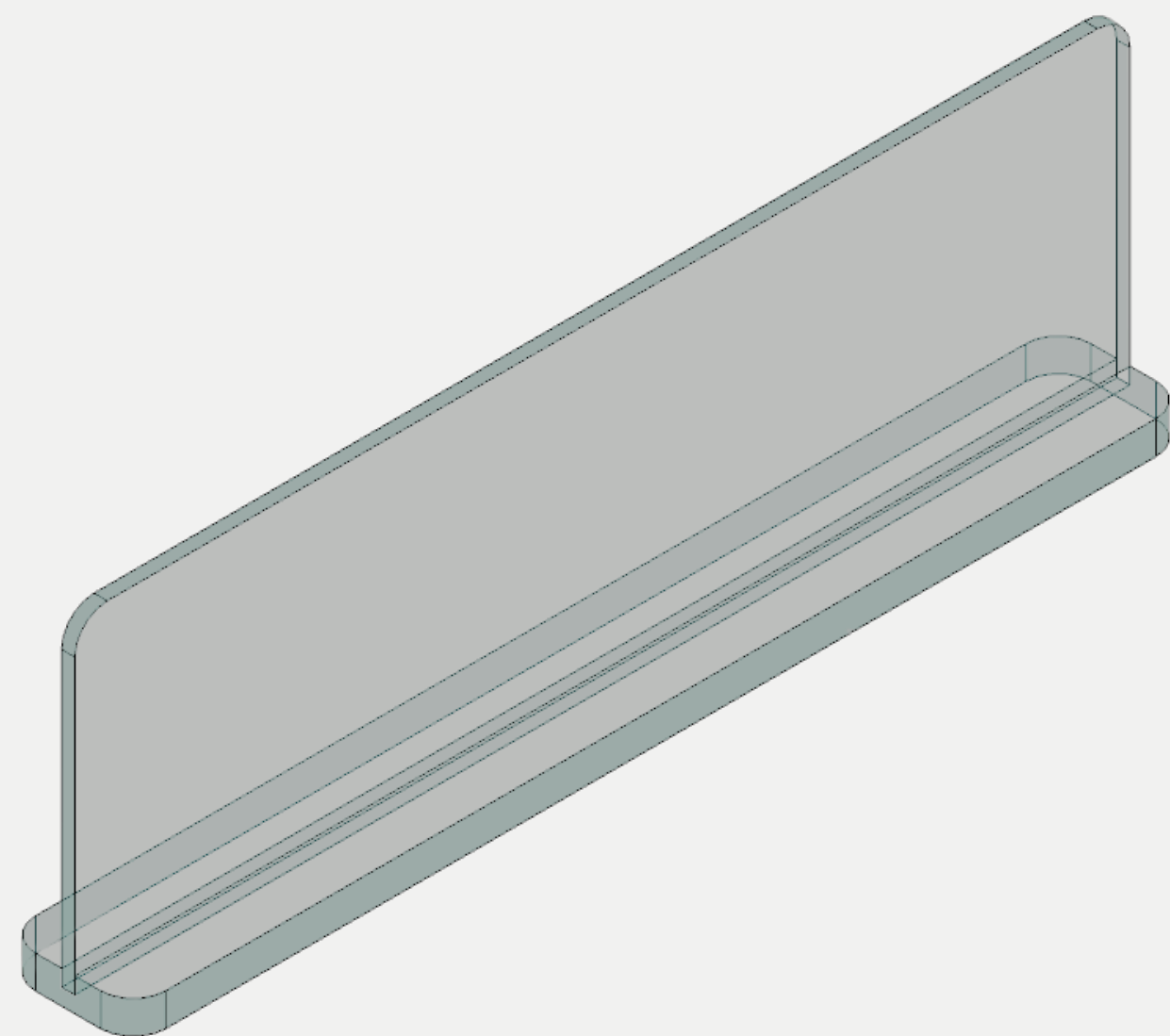

-N2 Splash Guard

Transparent polycarbonate splash guard

Provides safe protection while keeping the work area clean, without compromising the aesthetic of the space thanks to its transparency and discreet design.

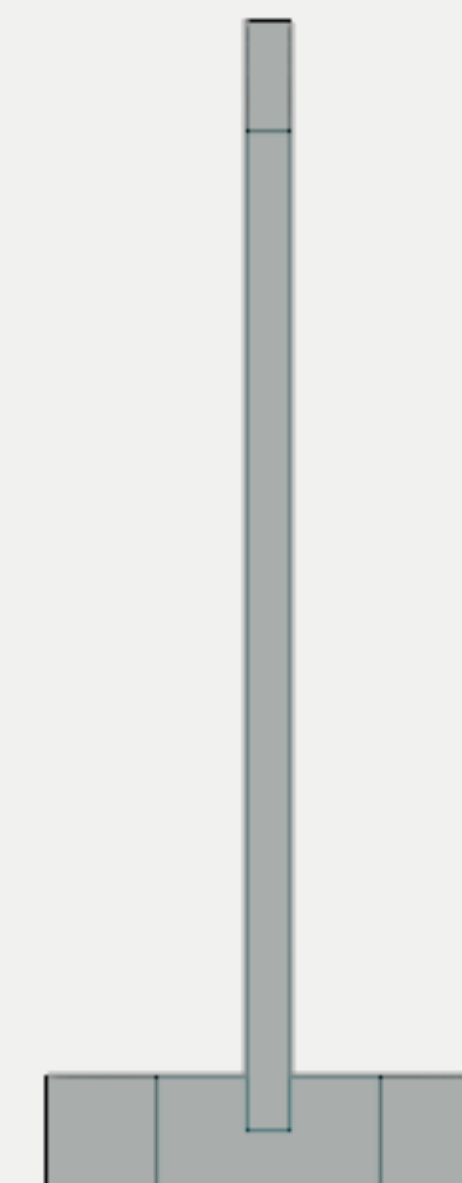

Polycarbonate

Dim: **W**x**L**x**H**

inch: **27,5** x **4,7** x **8,7**

cm: **70** x **12** x **22**

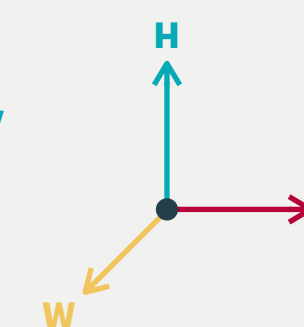



I RIVESTIMENTI: I PIANI

silestone®

By COSENTINO®

A leading brand for over 30 years that inspires designs for kitchens, bathrooms and commerciale surfaces.

25 Years warranty
Hybrid mineral surfaces to create innovative spaces that endure over the time.

Advantages and properties



Elevata resistenza ai graffi
l'uso e l'usura quotidiana non graffiano Silestone.

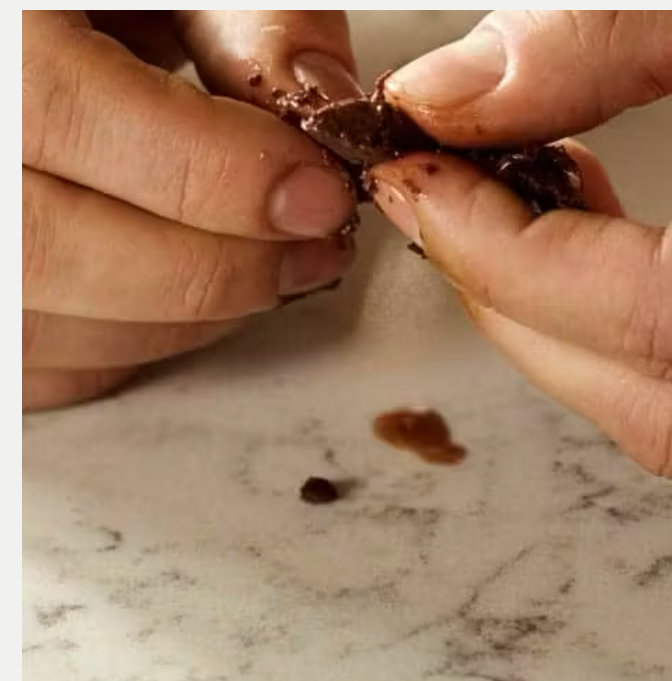

Elevata resistenza alle macchie
La bassa porosità li rende altamente resistenti alle macchie.



Alta resistenza agli urti
Altamente resistente agli impatti quotidiani.

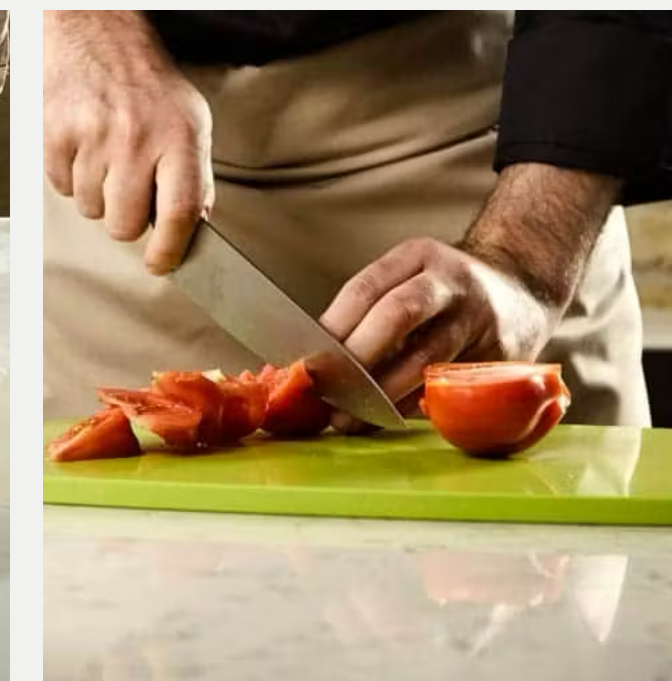

Elevata resistenza agli acidi
La bassa porosità gli impedisce di essere danneggiato da macchie aggressive.

Finish



Polished
More vibrant and intense colors and reflections

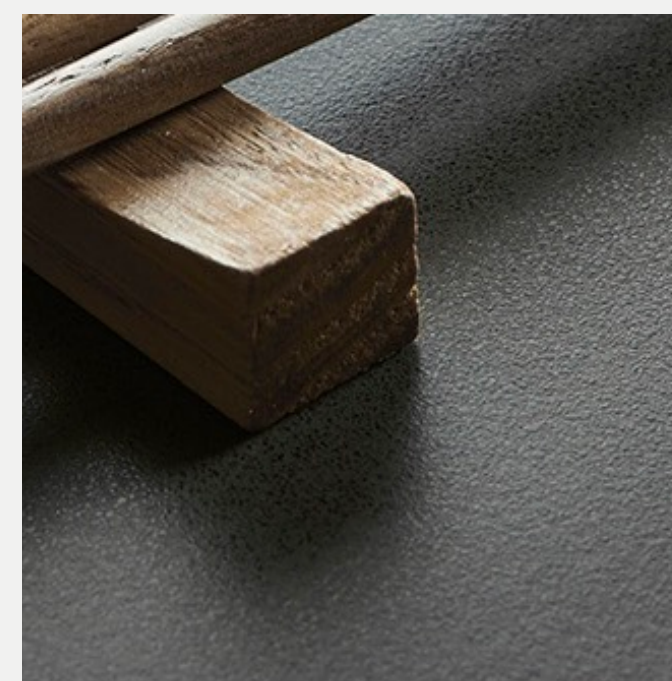

Suede
Soft and pleasant feel with full color consistency

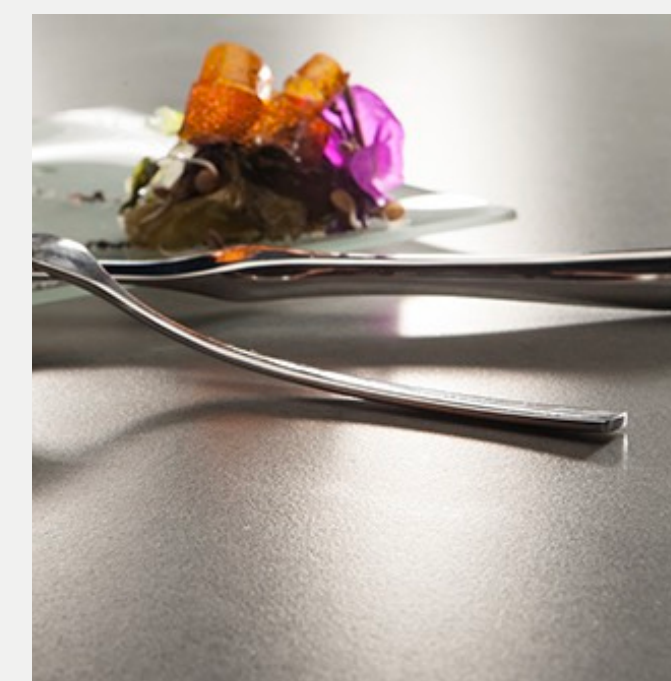

Mate
Solid and satin color

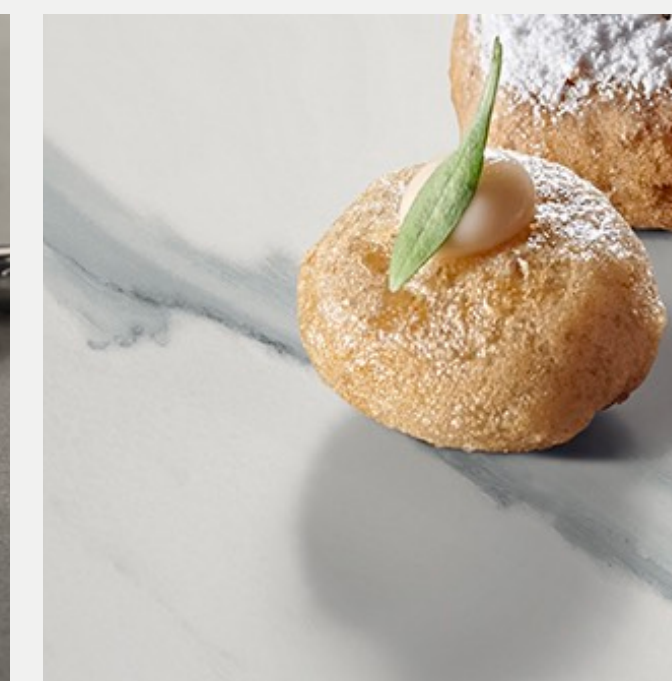

Velvet

Maintenance



Click the colors to see them in use

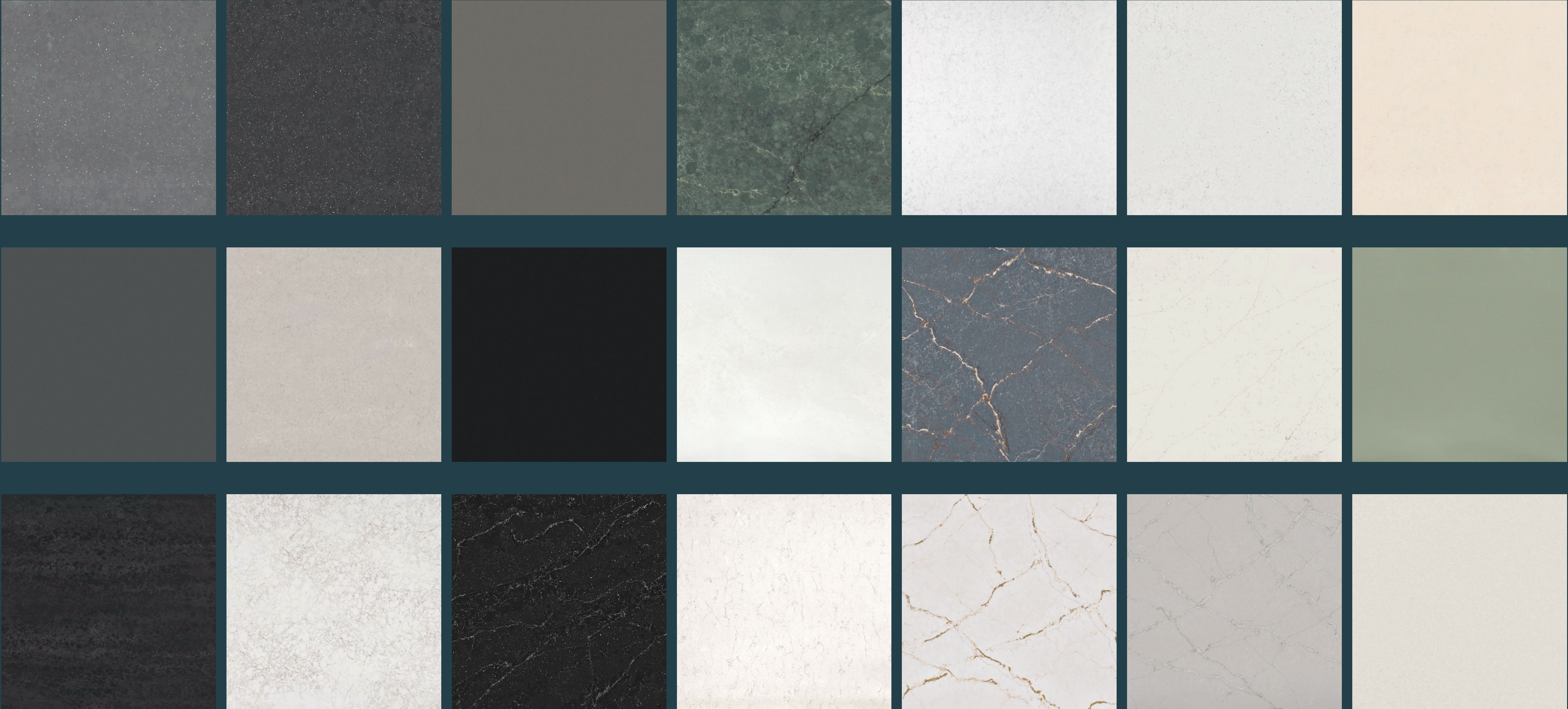

 **COLORS WITHOUT LIMITS**



[RAL Chart](#)

PANTONE®

[Pantone Chart](#)

kerakoll

[Kerakoll Chart](#)

With TekneItalia, you're never confined to a preset color palette. **We offer access to thousands of colors** through internationally recognized systems like **RAL** and **PANTONE***, ensuring your customization is truly **limitless**. Whatever shade you envision, we can bring it to life—without compromises and without boundaries.

 **COLORS WITHOUT LIMITS**

3M

DI-NOC™

3M™ DI-NOC™ Architectural E-Series PO Polyolefin Film are film surface finishes that give you a range of choices as you pursue your sustainability goals. These films are made with approximately 99.5% non-PVC (non-vinyl) materials, and do not contain more than 0.5% of a polyvinyl chloride-based component. **These finishes are available in various patterns and textures – wood, plaster, concrete and more, and are a great way to upgrade your interior look without all the disruption.** 3M™ Comply™ Adhesive technology virtually eliminates air bubbles, simplifying and speeding up the application process.



Catalogue 3M Di - NOC



TOTAL CUSTOMIZATION

With TekneItalia, every piece of furniture becomes a **unique expression of your brand**. **Integrated “under-surface” digital graphics, stencil techniques, and glossy or matte finishes are just some of the available options.** Thousands of combinations of materials, colors, and details allow you to create truly tailor-made solutions, with no limits to customization.





PROMINENT DETAILS

Laser-engraved details add depth and personality to the furniture, with the option to be painted or finished with an elegant 24-carat gold plating. **Custom-made**, these exclusive elements transform any space, making your venue unique and **instantly recognizable**.



THIS IS A **TEKNEITALIA**® PROJECT

Tekneitalia is a company founded **over 15 years ago** with the clear and ambitious goal of revolutionizing the way business is done in the HO.RE.CA. sector. Through **carts and mobile devices with iconic and highly recognizable design**, we have made **beauty a tool for work**. From day one, our mission has been to offer clients **not only functional tools but true extensions of their identity**: objects capable of expressing **values, emotions**, and visions through a refined and **timeless aesthetic**.

TEKNEITALIA®
Brows our website



TEKNEITALIA®



YOUR PROJECT, GUIDED BY EXPERT

A dedicated team of **architects and graphic designers** will support you at every stage of development, working closely with you to create the best version of your project. Thanks to 3D modeling in a virtual environment, you'll be able to explore every detail of your venue before implementation, choosing each element with precision and ensuring a flawless result.

Contact us and **share your needs** to discover how we can **turn your project into reality**. Receive detailed information and a personalized quote, with **no obligation**.

INFO@TEKNEITALIA.COM

MOBILE OFFICE: +39 328 221 34 74

MOBILE SALES EXPORT: + 39 366 421 23 63

TEKNEITALIA USA: +1 212 810 6725